

Milli-Q® SQ 2Series

USER MANUAL

MANUEL D'UTILISATION, MANUALE D'USO, BEDIENUNGSANLEITUNG,
MANUAL DE USUARIO, MANUAL DE INSTRUÇÕES, ユーザーマニュアル, 用户手册,
РУКОВОДСТВО ПОЛЬЗОВАТЕЛЯ

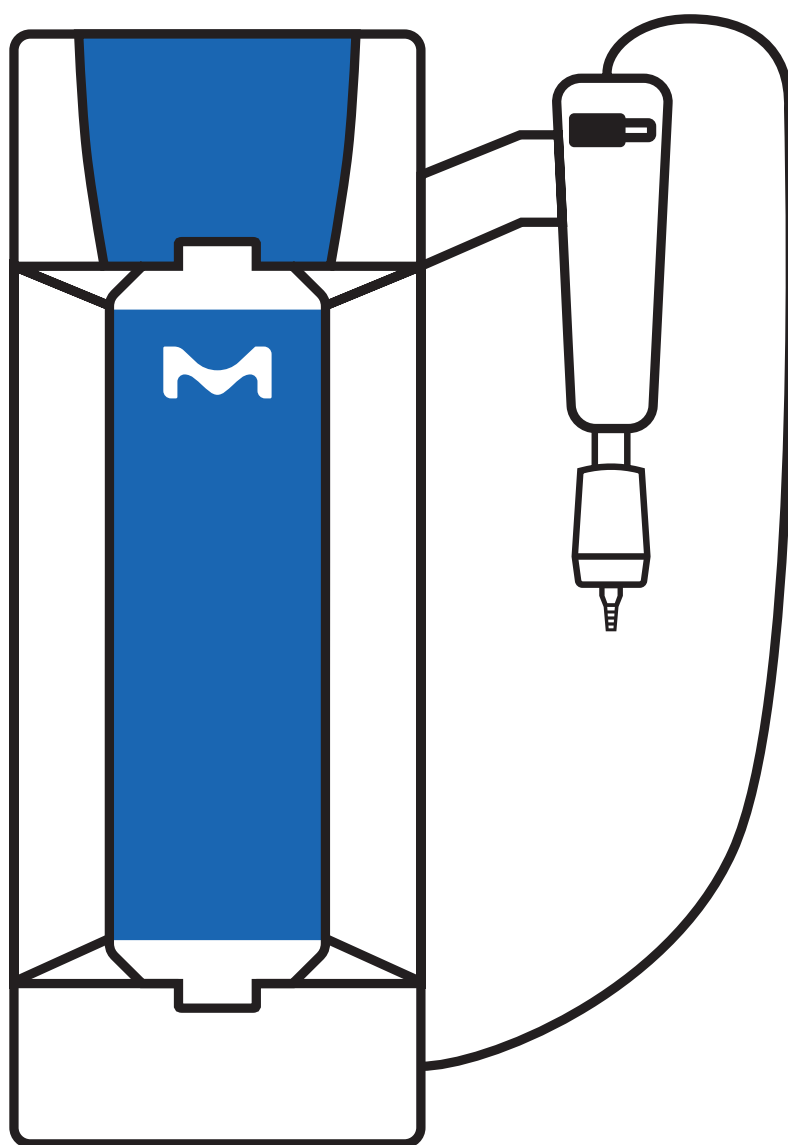

**Ultrapure
ZSQ200UPT0**

Milli-Q® SQ 2Series

Welcome to a modular universe

Bienvenue dans un univers modulaire / Benvenuto in un universo modulare / Herzlich Willkommen in einem modularen Universum / Bienvenido a un universo modular / Bem-vindo a um universo modular / モジュール式の世界によこそ / 欢迎来到一个模块化世界 / Добро пожаловать в мир модульных решений

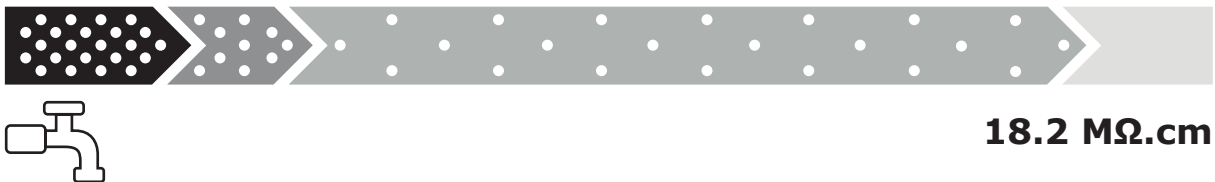
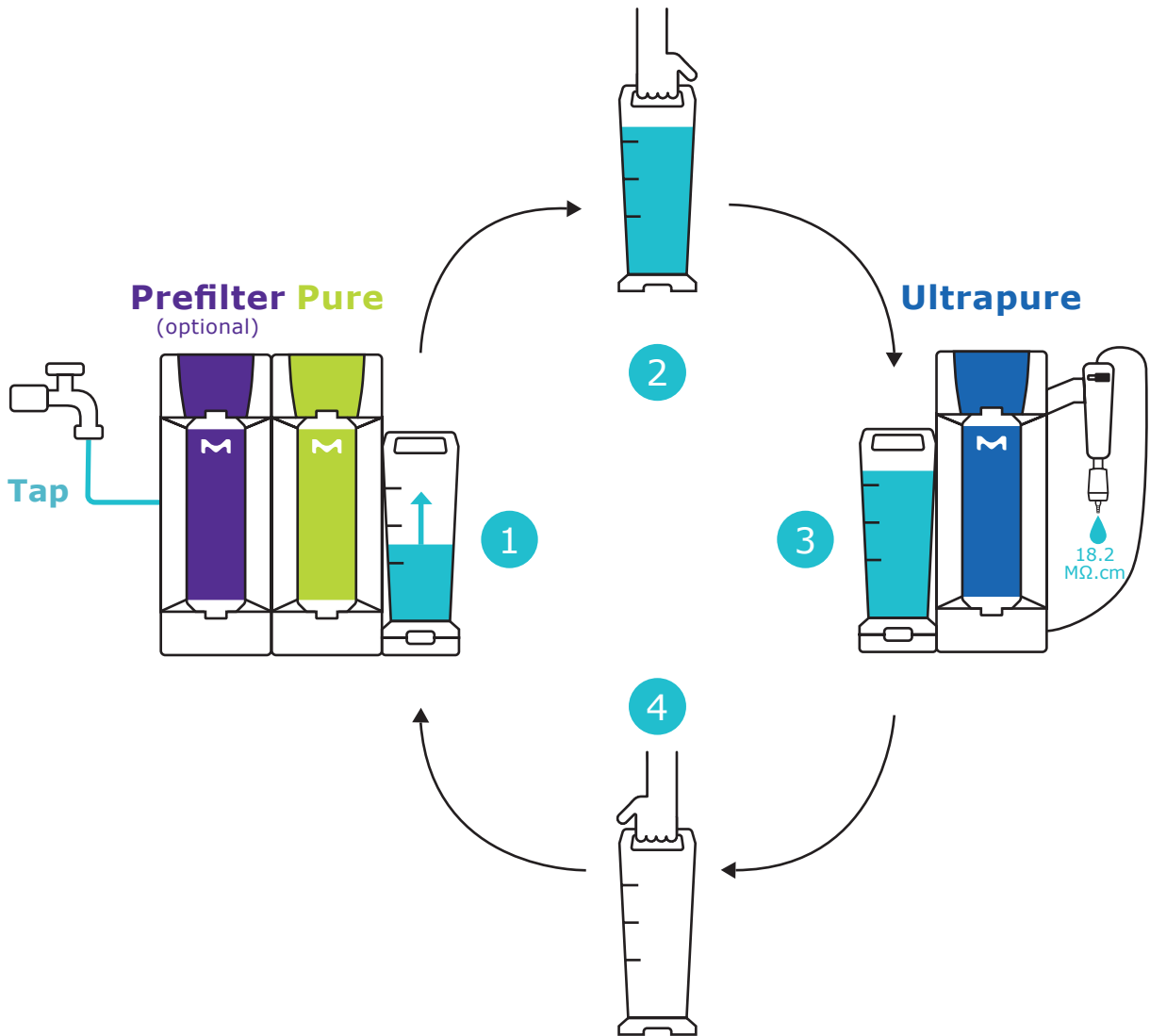

Adapt your setup to your evolving needs

Adaptez votre installation à l'évolution de vos besoins / Potrai adattare il tuo impianto all'evolversi delle tue necessità / Passen Sie das Setup an Ihre Anforderungen an / Adapte su configuración a sus necesidades en constante evolución / Adapte sua configuração às suas necessidades em evolução / 変化するニーズに設定を適合させましょう / 让您的设置适应您不断变化的需求 / Меняйте структуру в соответствии с растущими потребностями

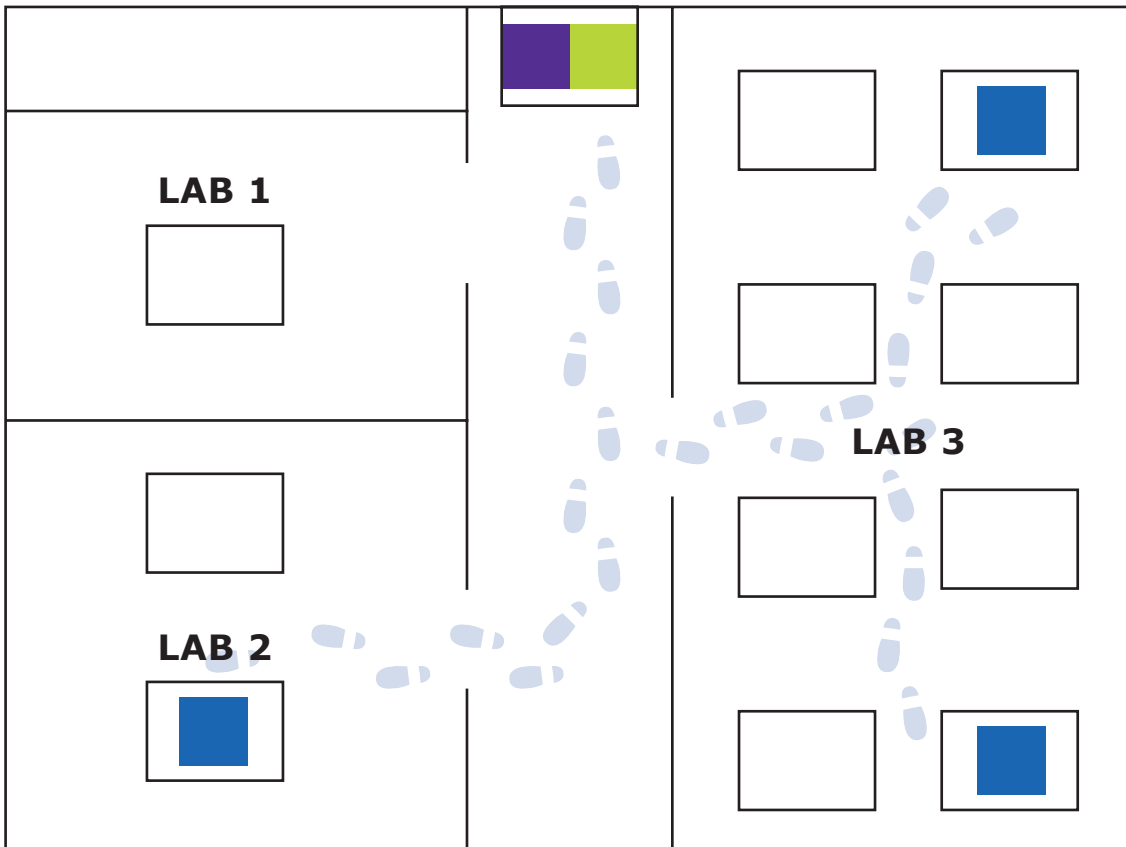







 **Prefilter** (optional)

 **Pure**

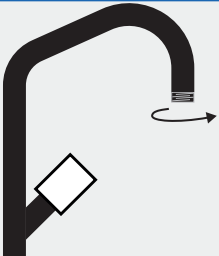
 **Ultrapure**

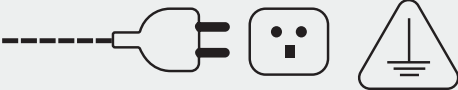
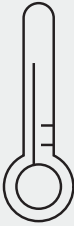
Connection Pre-requisite & Environmental

Prérequis de connexion et environnementaux / Prerequisiti ambientali e per le connessioni / Voraussetzungen für Anschlüsse & Umfeld / Requisitos previos de conexión y entorno / Pré-requisitos de conexão e ambientais / 接続、環境要件 / 连接及环境要求 / Подсоединение и необходимые условия окружающей среды

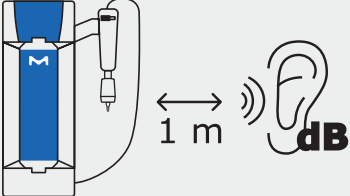
	<p>$Q_{max} \geq 120 \text{ L.h}^{-1} @ 1 \text{ bar}$</p> <p>P (bar) ? </p> <p> 1/2" Male NPT/BSP/GAZ</p>				
 <table border="1" data-bbox="683 860 1406 898"> <tr> <td>50/60 Hz 10%</td> <td>60 W</td> <td>100 - 240 V 10%</td> </tr> </table>			50/60 Hz 10%	60 W	100 - 240 V 10%
50/60 Hz 10%	60 W	100 - 240 V 10%			
 <p>C°</p>	 $4^{\circ}\text{C} \leq T \leq 40^{\circ}\text{C}$  $5^{\circ}\text{C} \leq T \leq 35^{\circ}\text{C}$	<p>Air and water / Air et eau / Aria e acqua / Luft und Wasser / Aire y agua / Ar e água / 空気と水 / 空气和水 / Воздух и вода</p>			
 <p>%</p>	<p>< 80 % @ 31°C, < 50 % @ 40°C</p>	<p>Relative humidity / Humidité relative / Umidità relativa / Relative Luftfeuchtigkeit / Humedad relativa / Umidade relativa / 相对湿度 / 相对湿度 / Относительная влажность</p>			
 <p>m</p>	<p>< 3000 m</p>	<p>Above sea level / Au-dessus du niveau de la mer / Sopra il livello del mare / Über dem Meeresspiegel / Sobre el nivel del mar / Acima do nível do mar / 海面以上 / 高于海平面 / Высота над уровнем моря</p>			
 <p>1 m dB</p>	<p>< 60 dB @ 1 m @ 20 KPa</p>				



Installation Guide

GUIDE D'INSTALLATION / GUIDA ALL'INSTALLAZIONE / INSTALLATIONSANLEITUNG / GUÍA DE INSTALACIÓN /
GUIA DE INSTALAÇÃO / 設置ガイド / 安装指南 / РУКОВОДСТВО ПО УСТАНОВКЕ





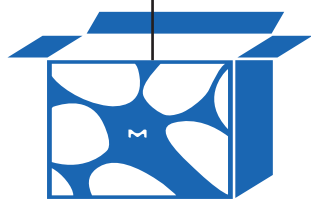
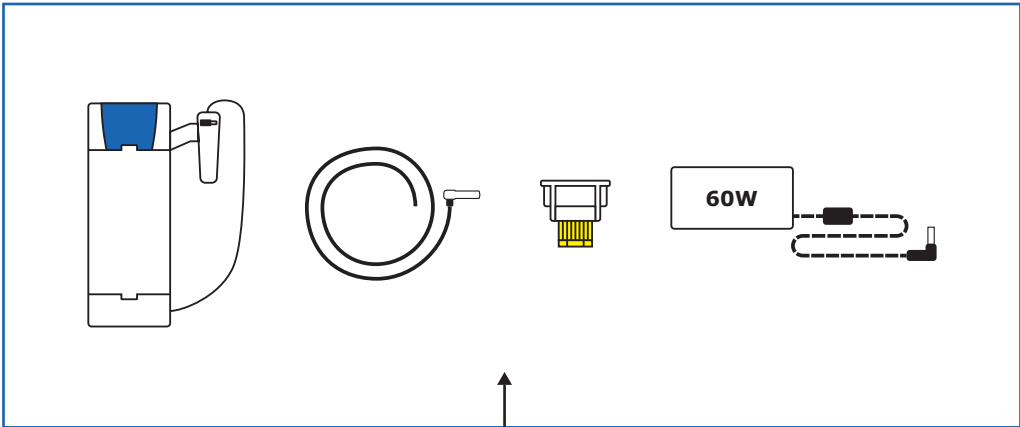

ZSQ200UPT0

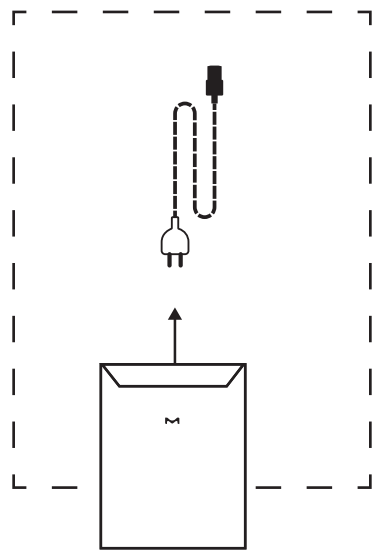
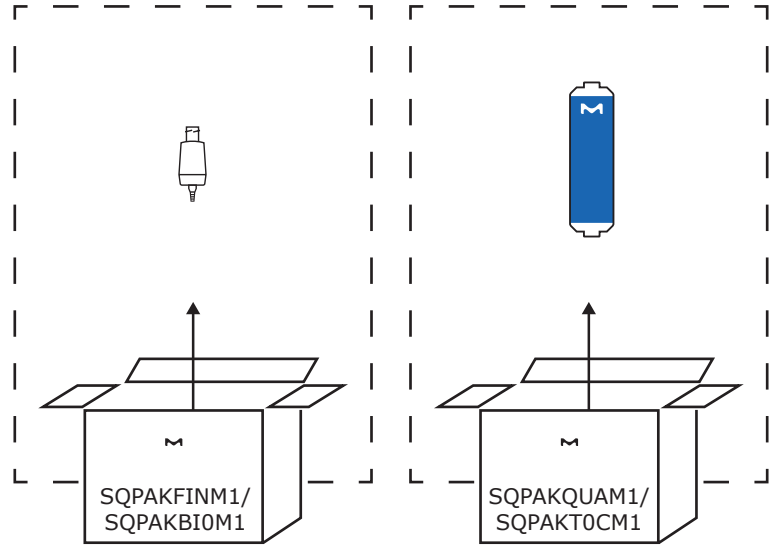



Installation

Installation / Installazione / Installation / Instalación / Instalação / 設置 / 安裝 / Установка

Ultrapure ZSQ200UPT0

$1 < P < 6 \text{ bar}$, $\sigma < 100 \text{ } \mu\text{S/cm}$
TOC < 50 ppb, $T < 35^\circ\text{C}$

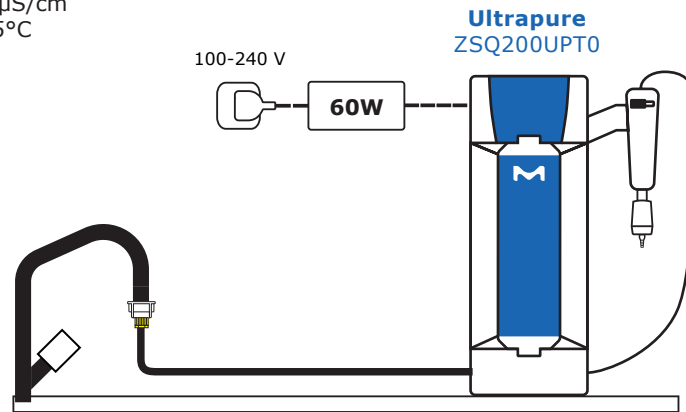

1

Optional

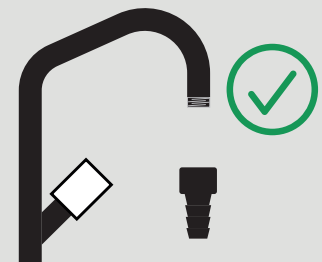
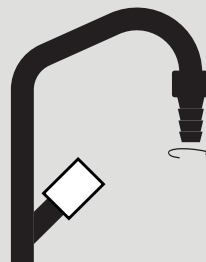
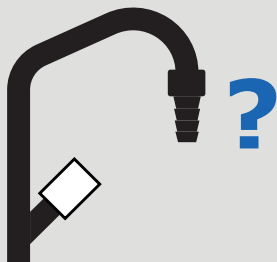

2

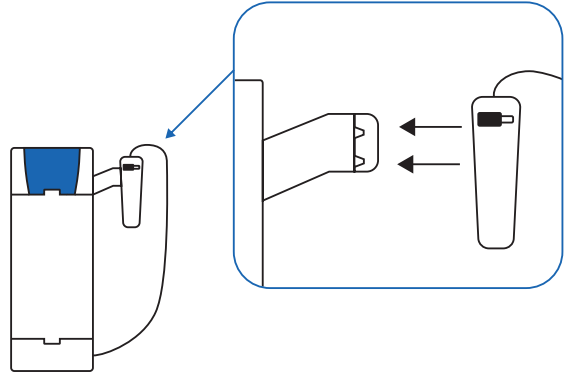

3

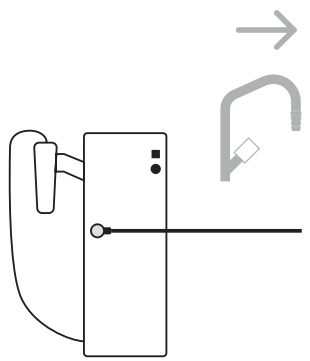
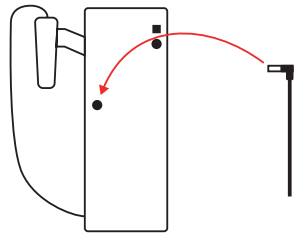
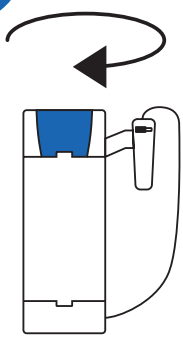

4

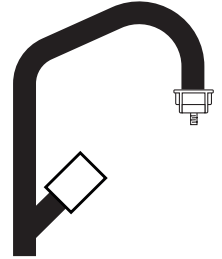
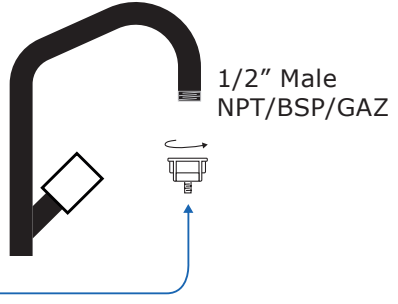
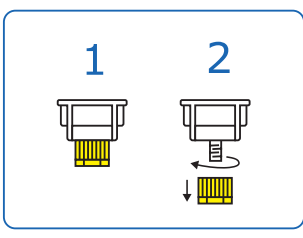

5

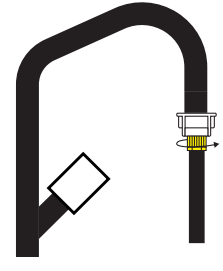
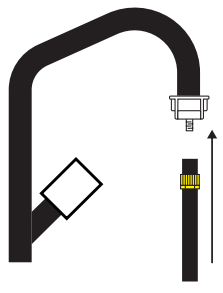
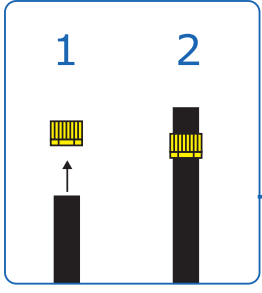

6

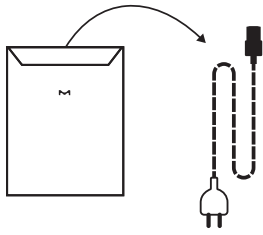

7

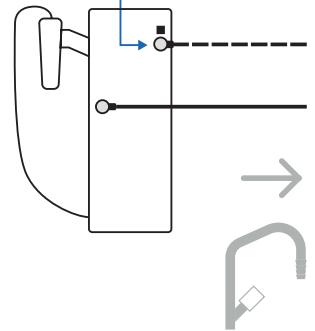
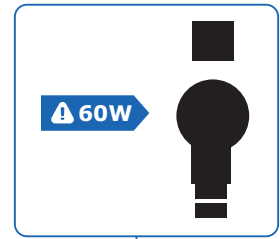
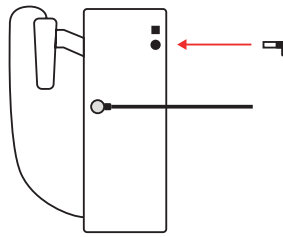
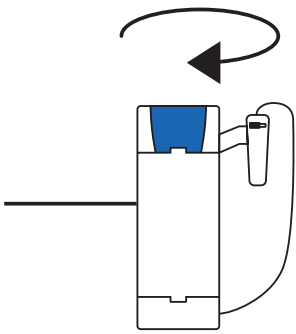

8

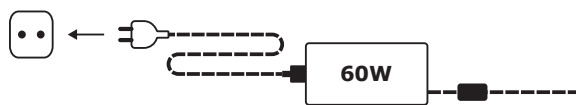

9

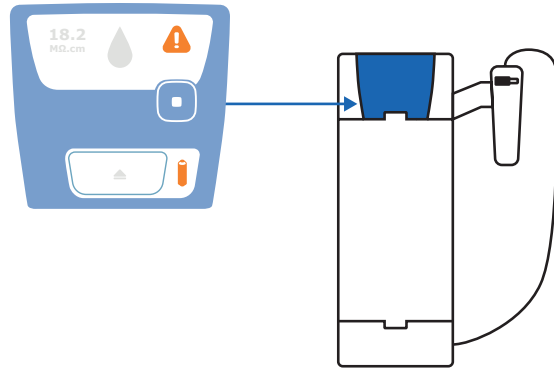

10

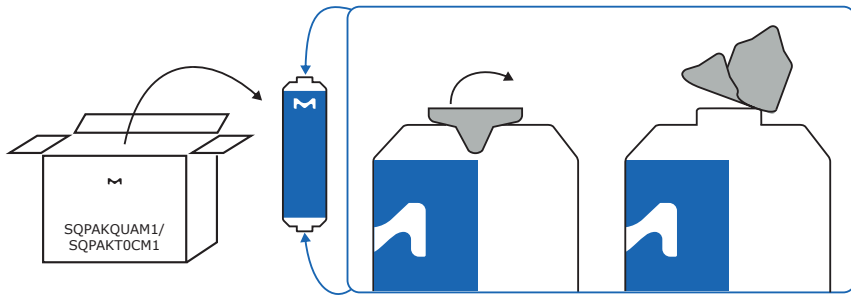

11

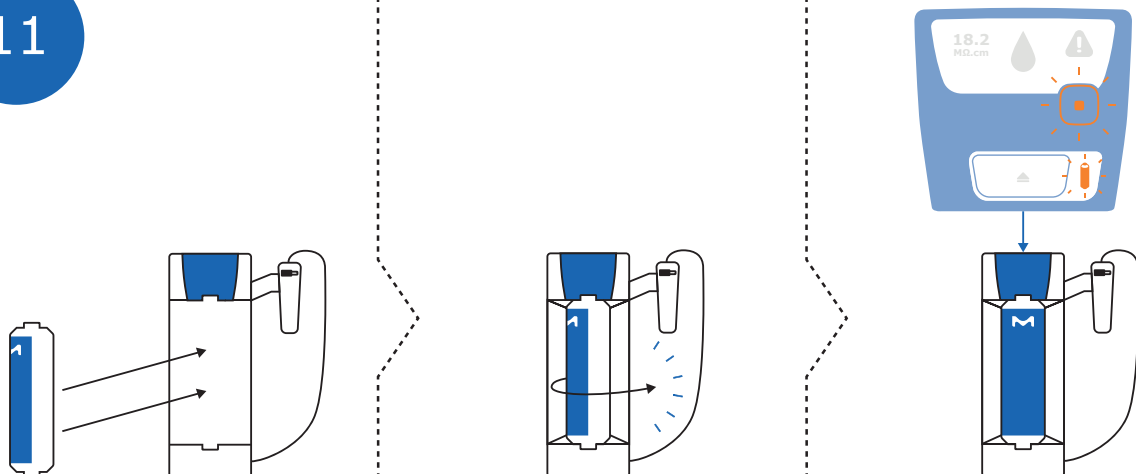

12

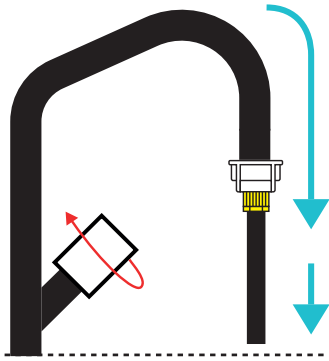

ON / OFF

13

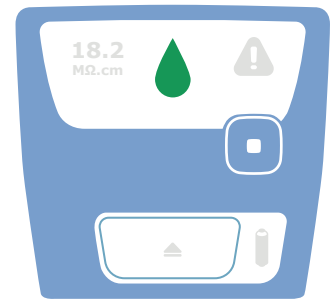
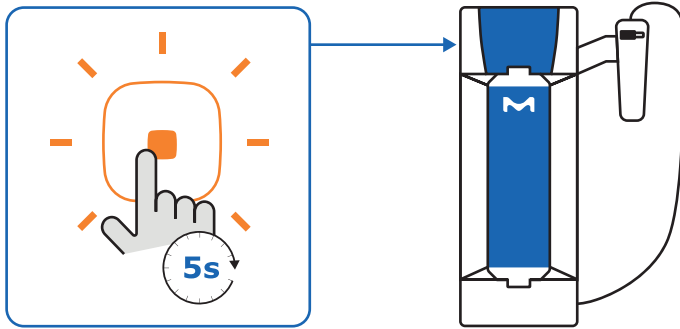

14

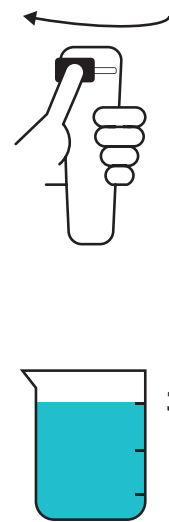
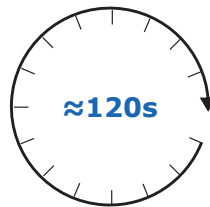
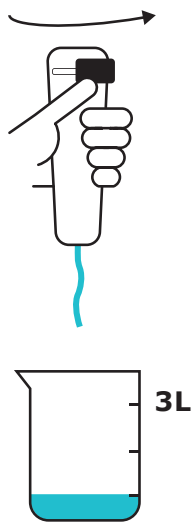

15

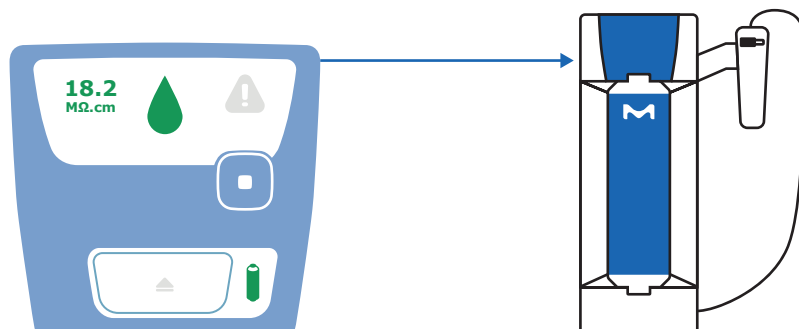

16

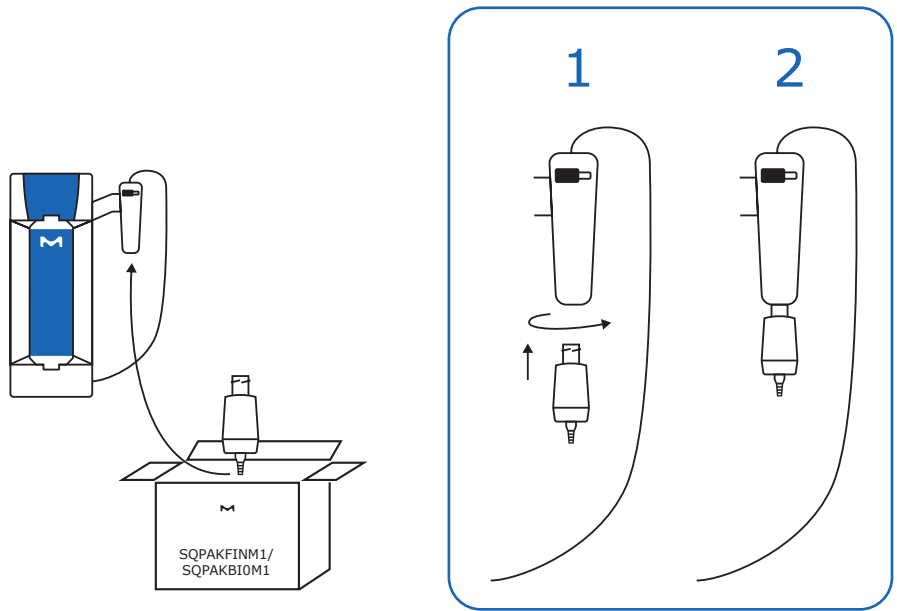

17

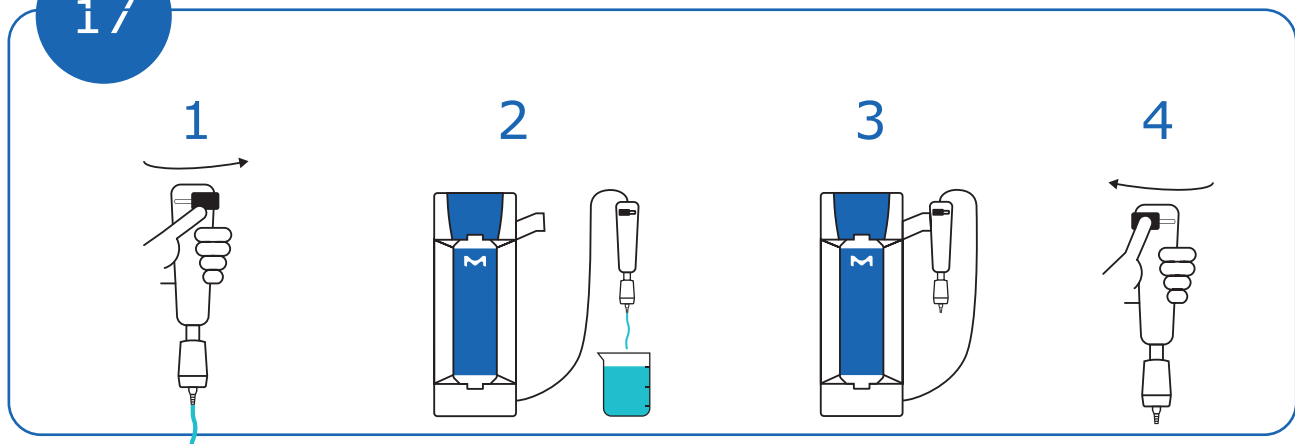

18

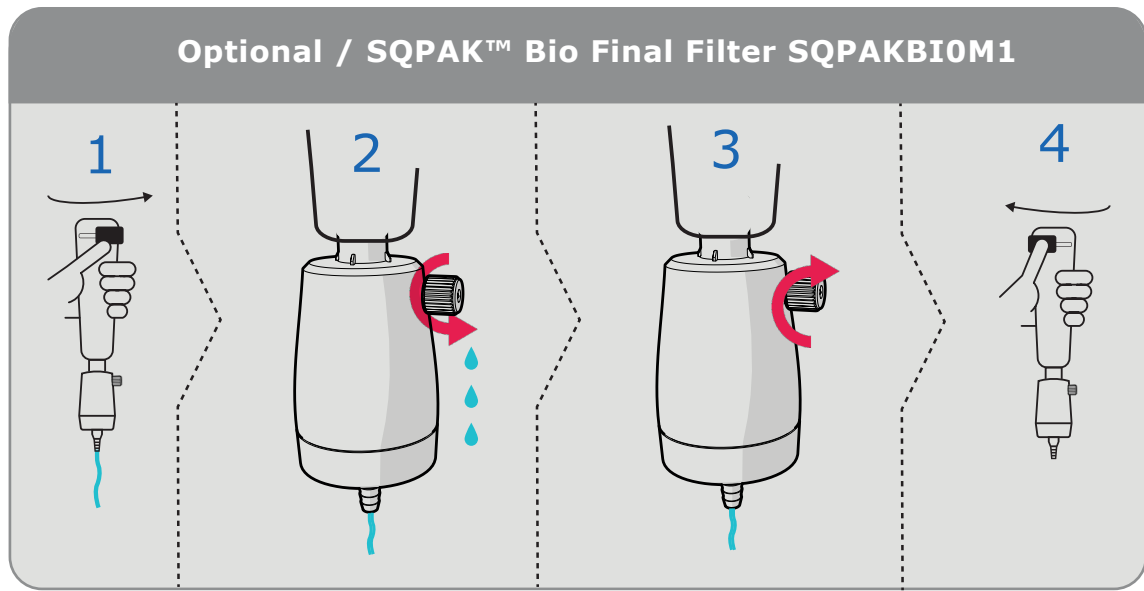

19

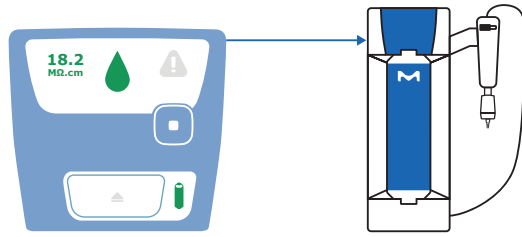



Accessories

ACCESSOIRES / ACCESSORI / ZUBEHÖR / ACCESORIOS / ACESSÓRIOS /
アクセサリ / 配件 / ДОПОЛНИТЕЛЬНЫЕ МАТЕРИАЛЫ



Accessory: Water Sensor Installation

Accessoire : Installation du détecteur d'eau / Accessorio: Installazione del sensore antiallagamento /
Zubehör: Installation des Wasserwächters / Accesorio: Instalación del sensor de agua /
Acessório: Instalação do sensor de água / アクセサリー:漏水センサーの設置 / 配件:漏水检测器安装 /
Дополнительный материал: Установка датчика воды

1

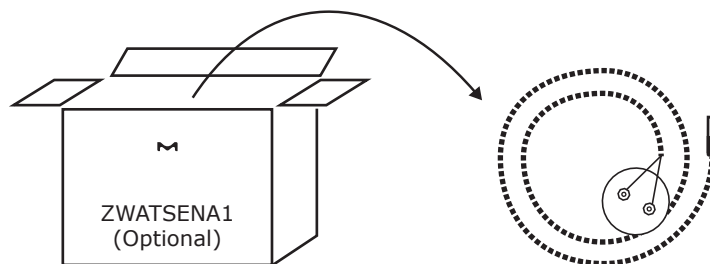

2

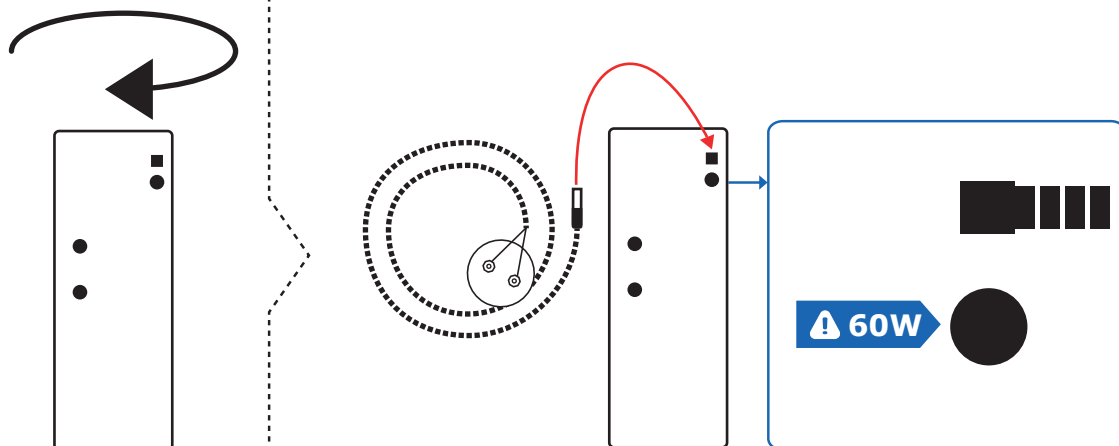

3

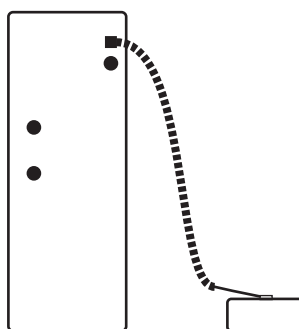



System Presentation

PRESENTATION DU SYSTÈME / PRESENTAZIONE DEL SISTEMA / SYSTEMDARSTELLUNG /
PRESENTACIÓN DEL SISTEMA / APRESENTAÇÃO DO SISTEMA / システムの説明 / 系統介绍 / ПРЕЗЕНТАЦИЯ СИСТЕМЫ





System Overview

Aperçu du système / Panorámica del sistema / Systemüberblick / Descripción del sistema / Visão geral do sistema / システムの概要 / 系統概述 / Обзор системы

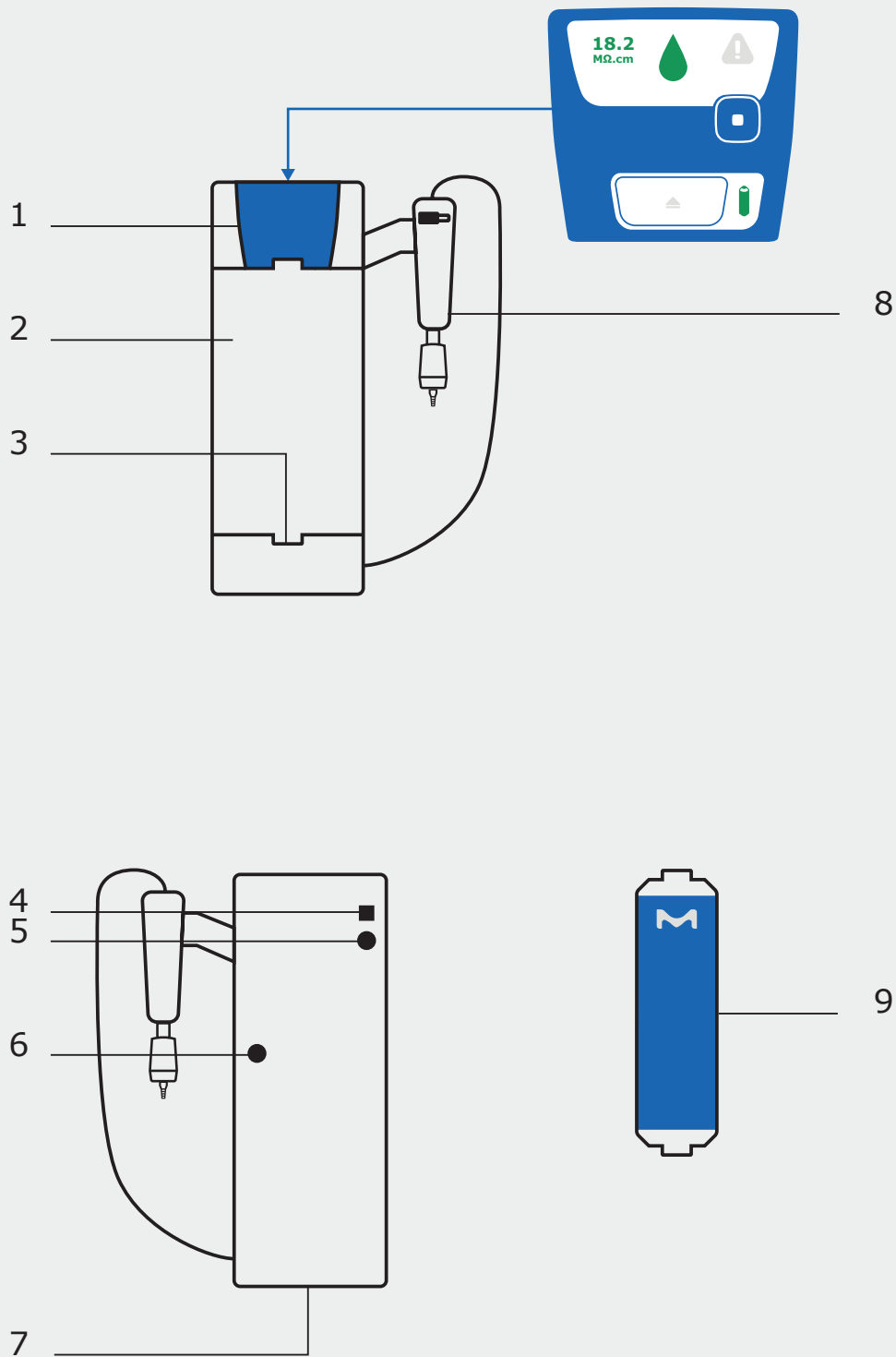

1. LED Interface	LED d'interface / LED dell'interfaccia / Schnittstellen-LED / LED del interfaz / LED de interface / インターフェイスのLED / 界面 LED 指示灯 / Светодиодные индикаторы интерфейса
2. System	Système / Sistema / System / Sistema / Sistema / システム / 系统 / Система
3. Cartridge holder	Support de cartouche / Portacartuccia / Filterelementhalter / Portacartuchos / Porta-cartucho / カートリッジホルダー / 滤柱座 / Держатель картриджа
4. Water sensor socket	Prise du détecteur d'eau / Presa per il sensore antiaggimento / Wasserwächterbuchse / Toma del sensor de agua / Soquete do sensor de água / 漏水センサーソケット / 漏水检测器插口 / Гнездо датчика воды
5. Power supply socket	Prise de l'alimentation électrique / Presa per l'alimentatore / Stromversorgungsbuchse / Toma de alimentación / Soquete da fonte de alimentação / 電源ソケット / 电源插座 / Гнездо источника питания
6. Pure pressurized feed water connection	Raccordement à l'eau pure d'alimentation sous pression / Connessione con l'alimentazione dell'acqua pura pressurizzata / Druckbetriebener Reinwasser-Speisewasseranschluss / Conexión de agua purificada de alimentación a presión / Conexão de água de alimentação pressurizada pura / 加压纯水供給口 / 加压纯水进水连接 / Соединение для подачи чистой воды под давлением
7. Firm label	Plaque de firme / Piastra fissa / Feste Platte / Placa de marca / Placa firme / 铭板 / 铭牌 (Firm plate) / Фирменная табличка
8. Dispenser	Distributeur / Erogatore / Entnahmeeinheit / Dispensador / Dispensador / 採水ユニット / 取水器 / Дозатор
9. Ultrapure cartridge	Cartouche Eau ultra pure / Cartuccia per la produzione di acqua ultrapura / Reinstwasser-Filterelement / Cartucho de agua ultrapura / Cartucho de água ultrapura / 超纯水カートリッジ / 超纯水滤柱 / Картридж со сверхчистой водой



Dimensions & Weights



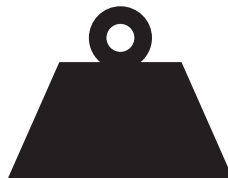
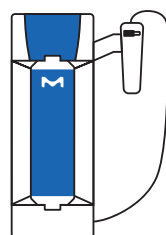
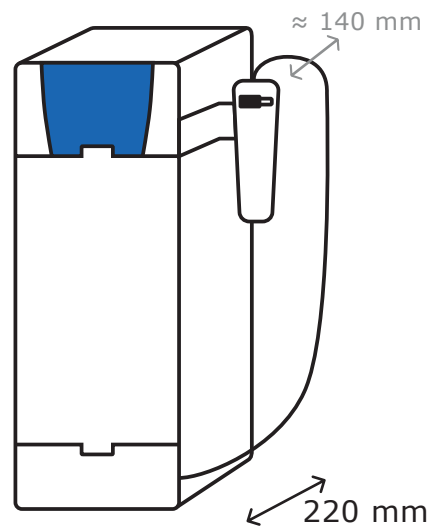
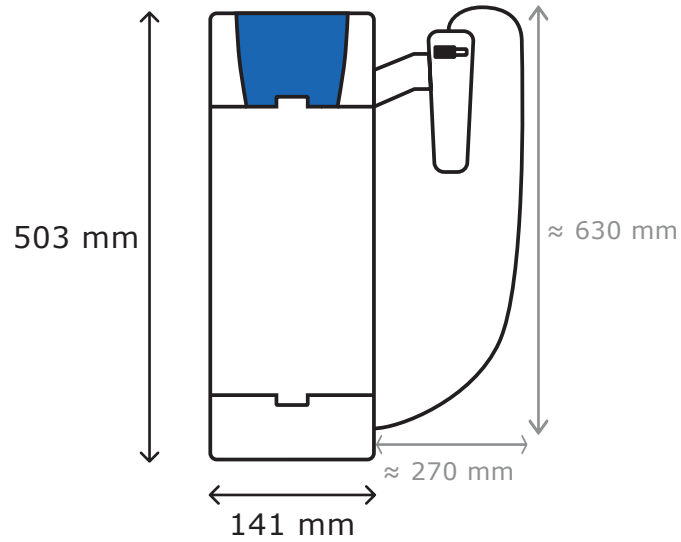





Dimensions et poids / Dimensioni e pesi / Abmessungen & Gewichte / Dimensiones y pesos / Dimensões e pesos /
寸法と重量 / 尺寸和重量 / Размеры и вес

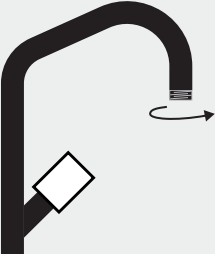

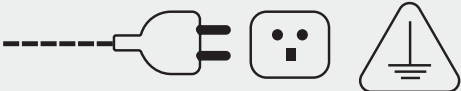
7 kg

Connection Pre-requisite & Environmental

Prérequis de connexion et environnementaux / Prerequisiti ambientali e per le connessioni / Voraussetzungen für Anschlüsse & Umfeld / Requisitos previos de conexión y entorno / Pré-requisitos de conexão e ambientais / 接続、環境要件 / 连接及环境要求 / Подсоединение и необходимые условия окружающей среды

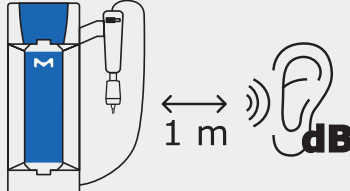
	<p>$Q_{max} \geq 120 \text{ L.h}^{-1} @ 1 \text{ bar}$</p> <p>P (bar) ? </p> <p> 1/2" Male NPT/BSP/GAZ</p>			
<div style="display: flex; align-items: center; justify-content: space-between;"> <div data-bbox="183 828 646 918">  </div> <table border="1" data-bbox="678 862 1404 907"> <tr> <td>50/60 Hz 10%</td> <td>60 W</td> <td>100 - 240 V 10%</td> </tr> </table> </div>		50/60 Hz 10%	60 W	100 - 240 V 10%
50/60 Hz 10%	60 W	100 - 240 V 10%		
	 $4^{\circ}\text{C} \leq T \leq 40^{\circ}\text{C}$  $5^{\circ}\text{C} \leq T \leq 35^{\circ}\text{C}$	<p>Air and water / Air et eau / Aria e acqua / Luft und Wasser / Aire y agua / Ar e água / 空気と水 / 空气和水 / Воздух и вода</p>		
	<p>< 80 % @ 31°C, < 50 % @ 40°C</p>	<p>Relative humidity / Humidité relative / Umidità relativa / Relative Luftfeuchtigkeit / Humedad relativa / Umidade relativa / 相对湿度 / 相对湿度 / Относительная влажность</p>		
	<p>< 3000 m</p>	<p>Above sea level / Au-dessus du niveau de la mer / Sopra il livello del mare / Über dem Meeresspiegel / Sobre el nivel del mar / Acima do nível do mar / 海面以上 / 高于海平面 / Высота над уровнем моря</p>		
	<p>< 60 dB @ 1 m @ 20 KPa</p>			

Technical Specifications

Spécifications techniques / Specifiche tecniche / Technische Daten / Especificaciones técnicas /
Especificações técnicas / 技術仕様 / 技术规格 / Технические характеристики

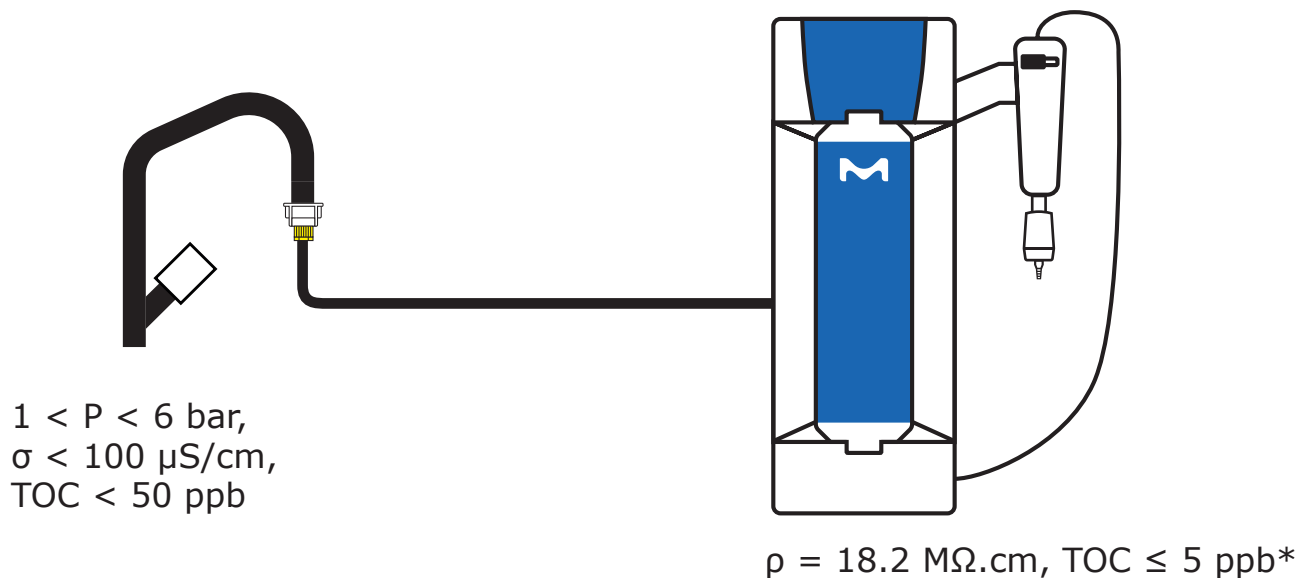

All parameters corrected @ 25°C /
Tous les paramètres corrigés à 25 °C /
Tutti i parametri corretti a 25 °C /
Alle Parameter korrigiert @ 25 °C /
Todos los parámetros corregidos a 25 °C /
Todos os parâmetros corrigidos a 25 °C /
全パラメーターは25°Cに補正 /
所有参数均在 25 °C 下校正 /
Все параметры скорректированы при температуре 25 °C



SQPAK TOC QUANTA Cartridge $\text{TOC} \leq 5 \text{ ppb}^*$



SQPAK™ Final Filter

Q ≤ 1.6 L/min

Particulates ≤ 0.22 μm

Particules / Particelle / Partikel / Partículas /
Particulados / 粒子/ 颗粒 / Частицы

Bacteria ≤ 10 CFU/L

Bactéries / Batteri / Bakterien / Bacterias /
Bactérias / 生菌数/ 细菌 / Бактерии

Organization Organisme / Ente / Organisation / Organización / Organização / 組織 / 组织 / Организация	Water quality / grade Qualité/Grade de l'eau / Qualità/grado dell'acqua / Wasserqualität / Calidad o grado del agua / Qualidade/grau da água / 水质グレード / 水质/级别 / Качество/класс воды
European Pharmacopeia	Purified water in bulk / Eau purifiée en vrac / Acqua purificata in bulk / Gereinigtes Wasser in Großmengen / Água purificada a granel / Água purificada a granel / バルク精製水 / 散装纯水 / Очищенная вода нерасфасованная
U.S. Pharmacopeia	
Japanese Pharmacopoeia / 日本薬局方	Purified water / Eau purifiée / Acqua purificata / Gereinigtes Wasser / Água purificada / Água purificada / 精製水 / 纯水 / Очищенная вода
Chinese Pharmacopoeia / 中国药典	
ASTM® D1193	Type I water / Eau de Type I / Acqua di Tipo I / Wasser vom Typ I / Agua de tipo I / Água tipo I / タイプ I 水 / I 类水 / Вода типа I
ISO® 3696	Grade 1 water / Eau de classe 1 / Acqua di Grado 1 / Wasser der Qualität 1 / Agua de grado 1 / Água de grau 1 / グレード1水 / 1 级水 / Вода класса 1
Chinese National Standard GB/T 6682 / 中国国家标准 GB/T 6682	
Chinese National Standard GB/T 33087 / 中国国家标准 GB/T 33087	Ultrapure water / Eau ultra pure / Acqua ultrapura / Reinstwasser / Agua ultrapura / Água ultrapura / 超纯水 / 超纯水 / Сверхчистая вода
JIS K 0557	A4 water / Eau A4 / Acqua A4 / A4-Wasser / Agua A4 / Água A4 / A4水 / A4 水 / Вода A4
Clinical and Laboratory Standards Institute (CLSI®)	Clinical Laboratory Reagent Water (CLRW) / Eau de qualité CLRW / Acqua a grado reagente per il laboratorio clinico CLRW / Reinwasser für das klinische Labor CLRW / Água de calidad reactiva para laboratorios clínicos CLRW / Água reagente para laboratórios clínicos CLRW / Clinical Laboratory Reagent Water (CLRW) / 临床实验室试剂水 (CLRW) / Вода клинического лабораторного назначения CLRW



SQPAK™ Bio Final Filter

Q ≤ 0.7 L/min

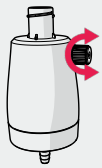

<p>Bacteria Bactéries / Batteri / Bakterien / Bacterias / Bactérias / 生菌数 / 細菌 / Бактерии</p>	<p>< 10 CFU/L</p>
<p>Pyrogens (endotoxins) Pyrogènes (endotoxines) / Pirogeni (endotossine) / Pyrogene (Endotoxine) / Pirógenos (endotoxinas) / Pirogênios (endotoxinas) / 파이로젠(엔도톡신) / 热原(内毒素) / Пирогены (эндотоксины)</p>	<p>< 0.001 EU/mL</p>
<p>RNases RNases / RNasi / RNasen / ARNasas / RNases / RNase / 核糖核酸酶 (RNase) / РНКазы</p>	<p>< 1 pg/mL</p>
<p>DNases DNases / DNasi / DNasen / ADNasas / DNases / DNases / 脱氧核糖核酸酶 (DNases) / ДНКазы</p>	<p>< 5 pg/mL</p>
<p>Proteases Protéases / Proteasi / Proteasen / Proteasas / Proteases / プロテアーゼ / 蛋白酶 / Протеазы</p>	<p>< 0.15 µg/mL</p>



User Manual

MANUEL D'UTILISATION / MANUALE D'USO / BEDIENUNGSANLEITUNG / MANUAL DE USUARIO /
MANUAL DO USUÁRIO / ユーザーマニュアル / 用户手册 / РУКОВОДСТВО ПОЛЬЗОВАТЕЛЯ





How To Use

Mode d'emploi / Istruzioni per l'uso / Anwendung / Cómo utilizar / Como usar /
ご利用方法 / 如何使用 / Способ применения

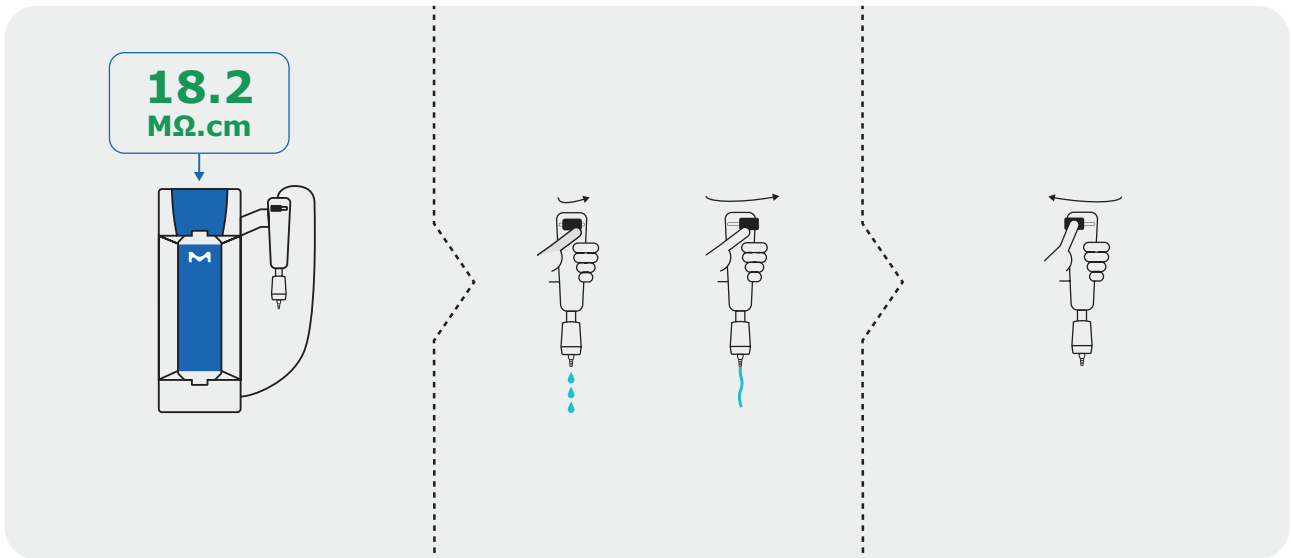

Signals & Messages



Signaux et messages / Segnali e messaggi / Signale & Mitteilungen / Señales y mensajes / Sinais e mensagens /
シグナルとメッセージ / 信号和消息 / Сигналы и сообщения

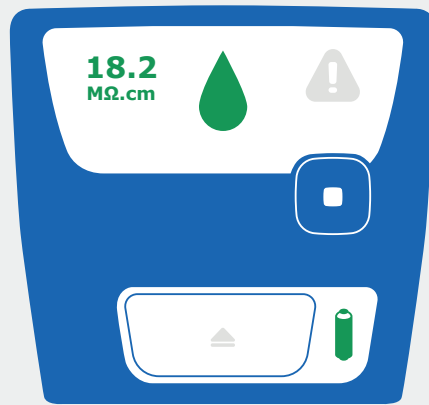

18.2
MΩ.cm

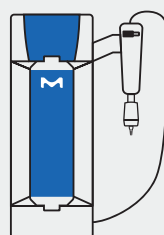
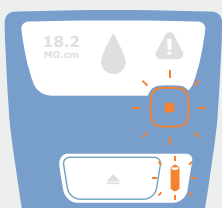
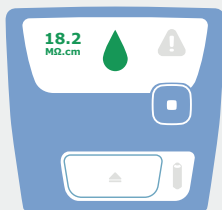
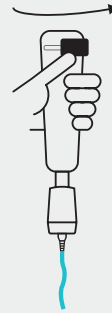
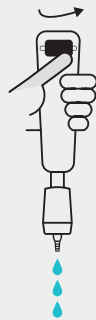



Troubleshooting

Dépannage / Risoluzione dei problemi / Fehlersuche / Resolución de problemas / Resolução de problemas /
トラブルシューティング / 故障排除 / Устранение неполадок

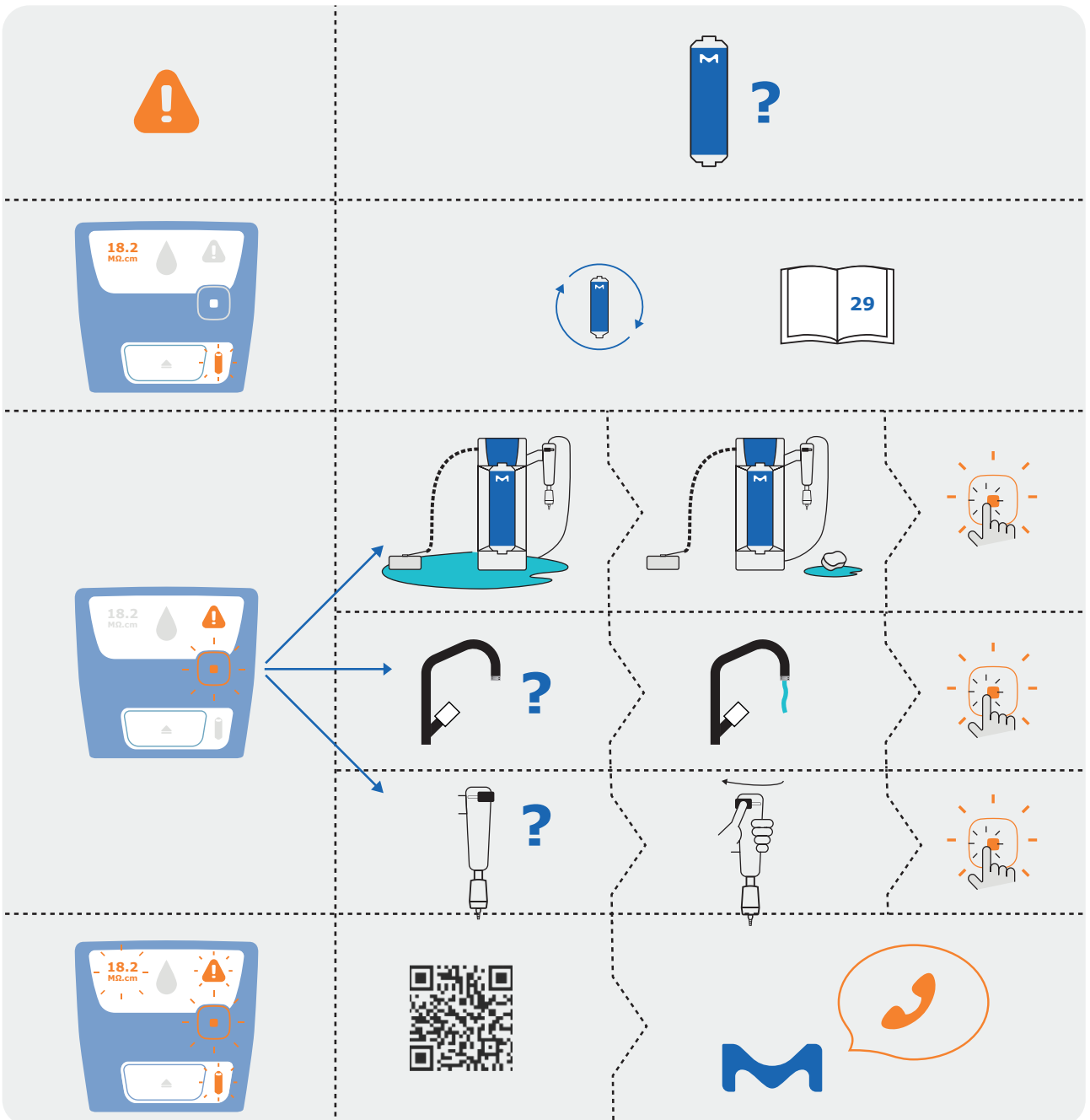

Cartridge Replacement



Remplacement des cartouches / Sostituzione delle cartucce / Ersetzen von Filterelementen / Sustitución del cartucho /
Substituição do cartucho / カートリッジの交換 / 滤芯更换 / Замена картриджа

1

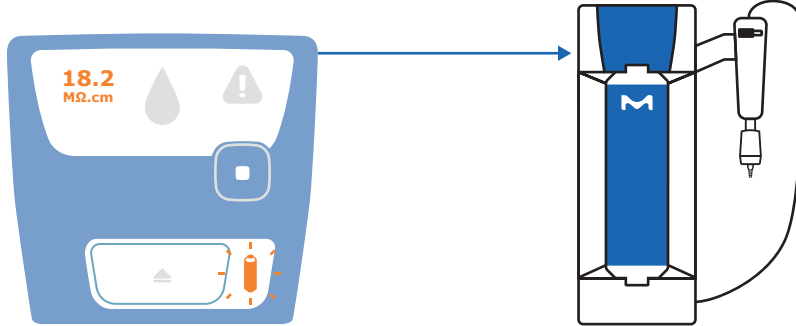

2

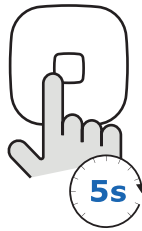

3

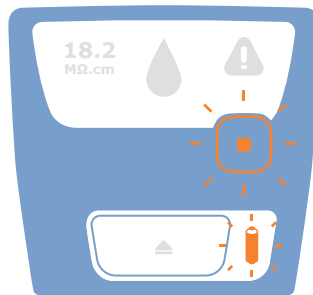

4

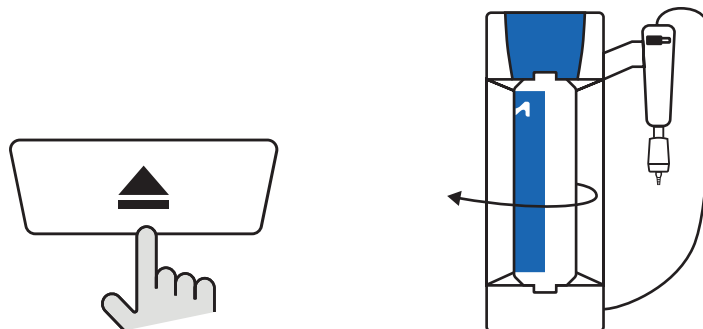

5

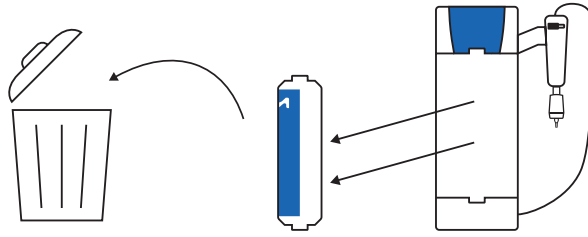

6

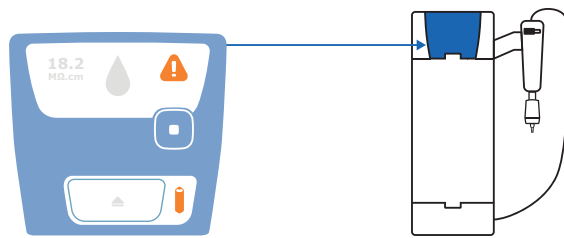

7

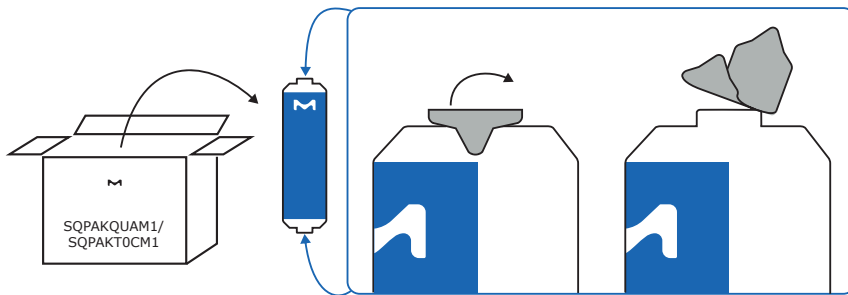

8

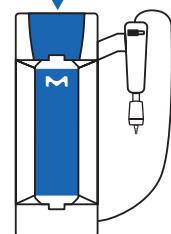
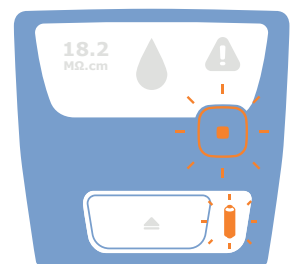
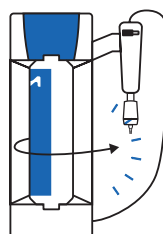
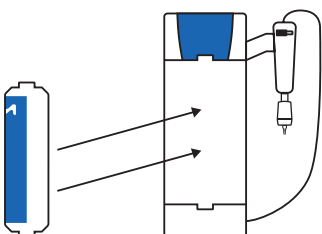

9

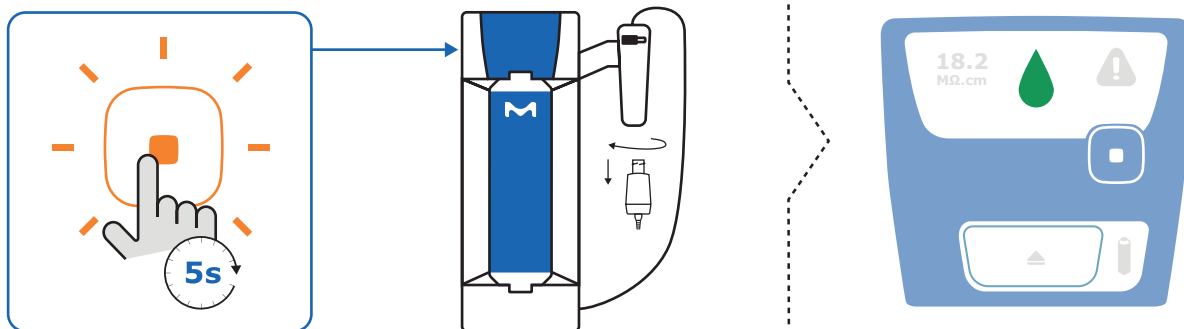

10

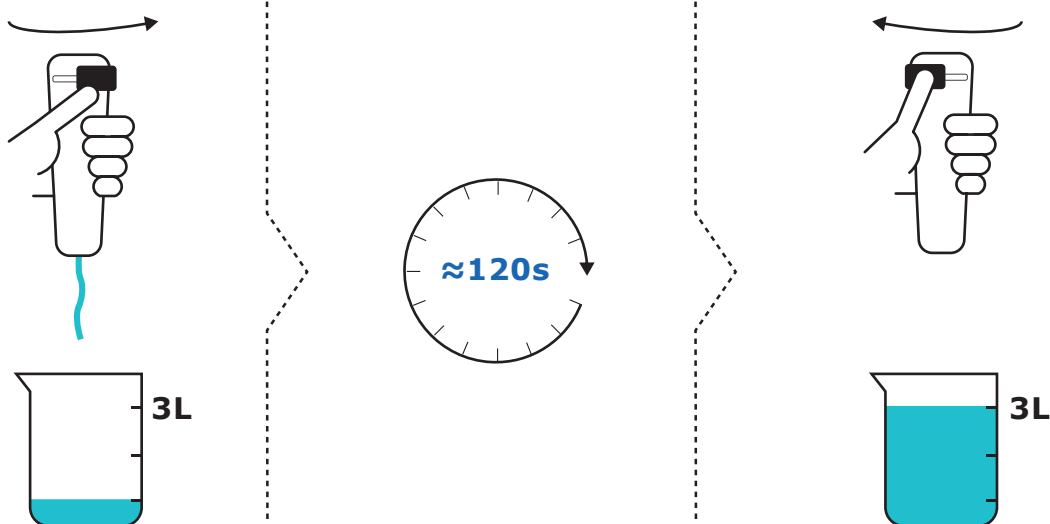

11

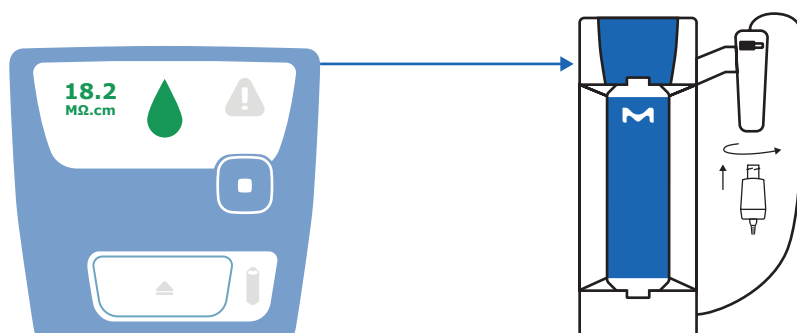

Final Filter Replacement

Remplacement du filtre final / Sostituzione del filtro finale / Ersetzen des Endfilters / Sustitución del filtro final /
 Substituição do filtro final / 最終フィルターの交換 / 终端过滤器更换 / Замена конечного фильтра

1

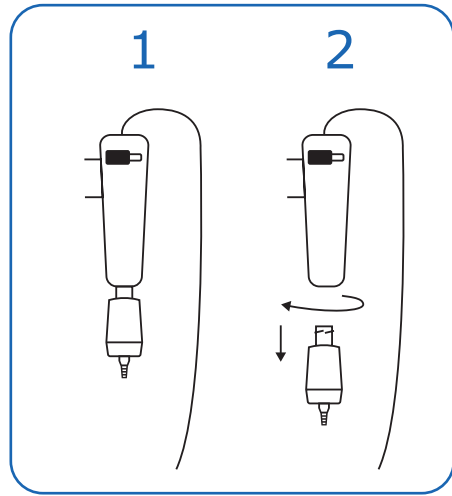
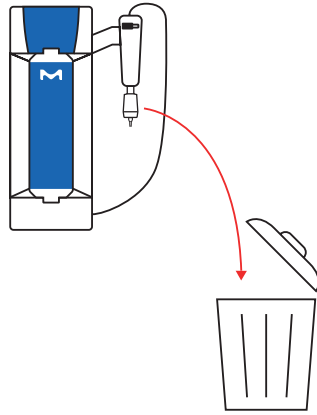

2

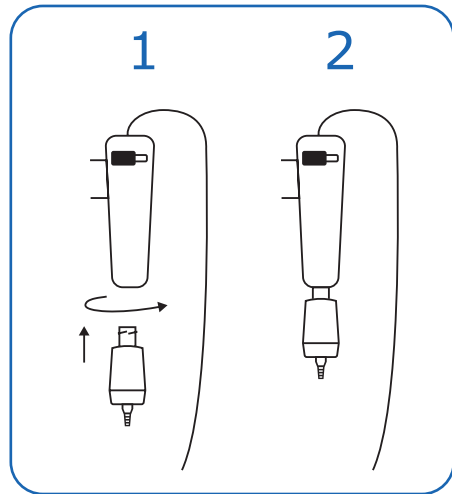
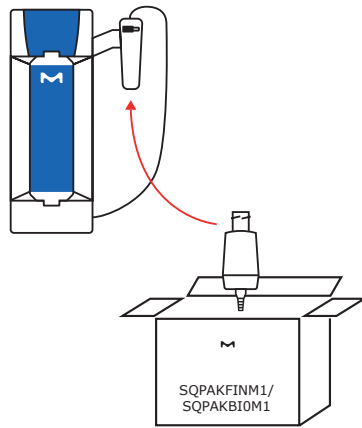

3

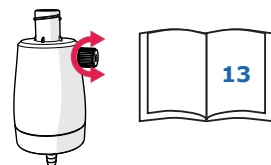
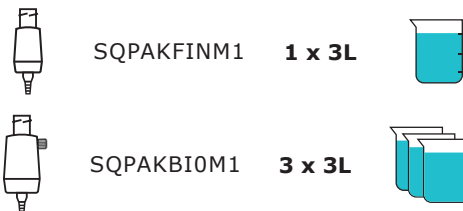
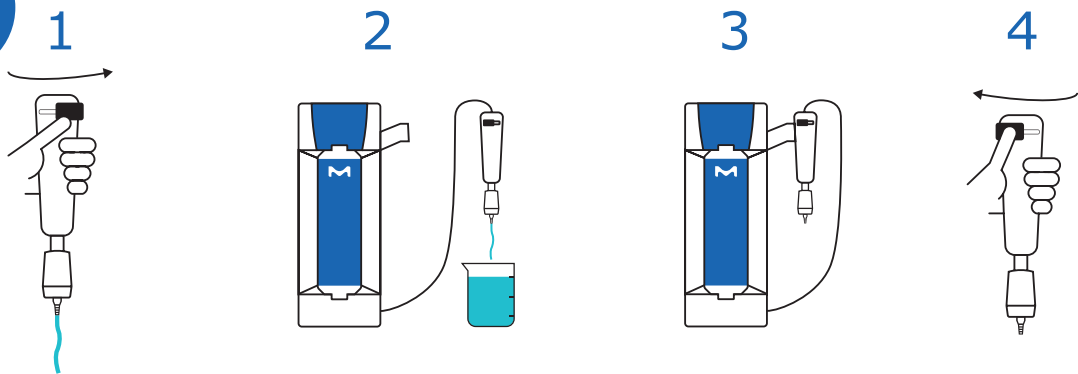



Ordering Information

GUIDE D'ACHAT / INFORMAZIONI PER GLI ORDINI / BESTELLINFORMATIONEN / INFORMACIÓN PARA PEDIDOS /
INFORMAÇÕES PARA PEDIDOS / ご注文情報 / 订货信息 / ИНФОРМАЦИЯ ДЛЯ ЗАКАЗА





Ordering Information

Guide d'achat / Informazioni per gli ordini / Bestellinformationen / Información para pedidos /
Informações para pedidos / ご注文情報 / 订货信息 / Информация для заказа

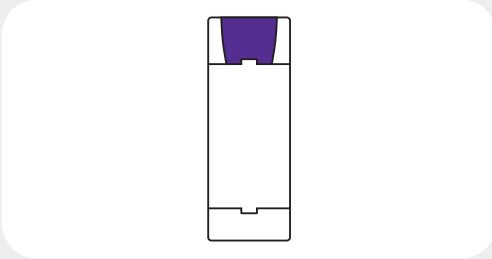

ZSR240PFT0
Milli-Q® SP 240 Prefilter Module

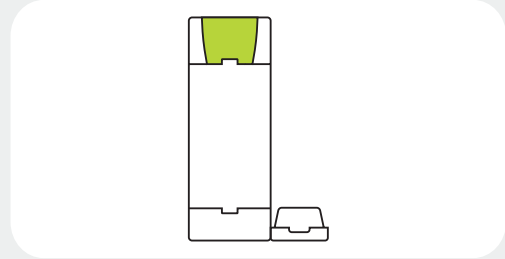

ZSR240R0T0
Milli-Q® SR 240 Purification System

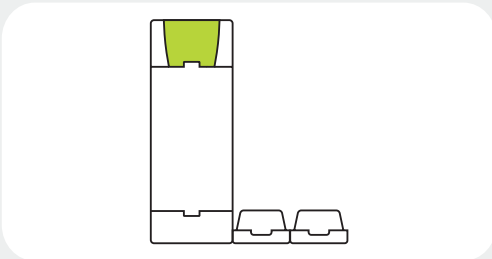

ZSR240RLT0
Milli-Q® SR 240L Purification System

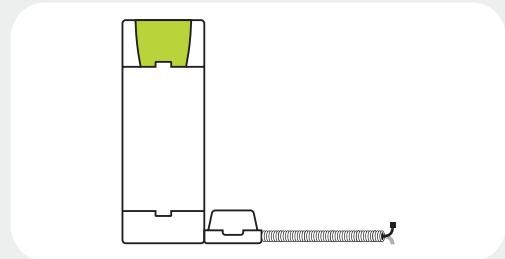

ZSR240RXT0
Milli-Q® SR 240XL Purification System

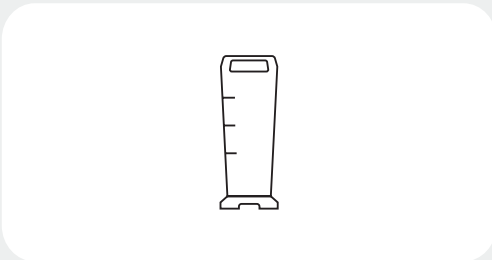

TANKSQ003
Milli-Q® SQ Switch 3.5L Tank

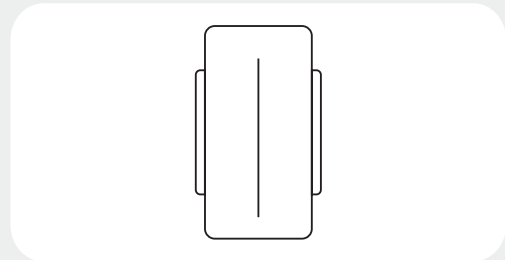

TANKSQ050
Milli-Q® SQ XL 50L Tank

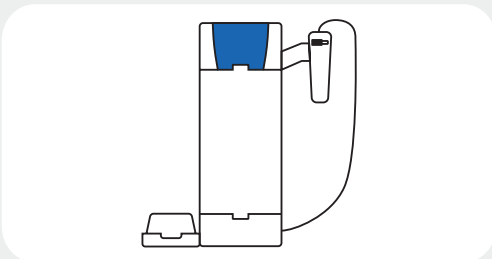

ZSQ200U0T0
Milli-Q® SQ 200 Purification System

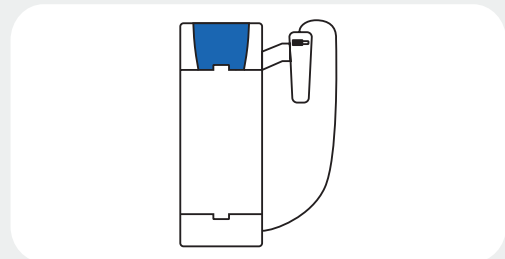

ZSQ200UPT0
Milli-Q® SQ 200P Purification System

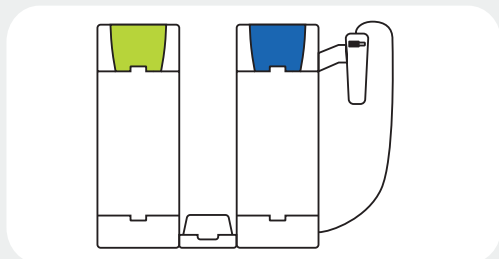

ZSQ240UCT0
Milli-Q® SQ 240C Purification System

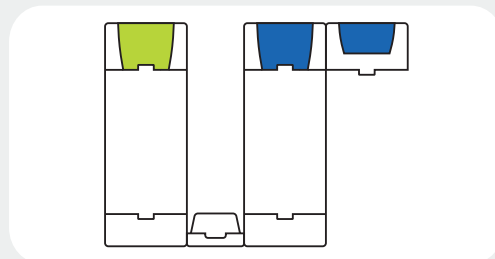

ZSQ240UCVT0
Milli-Q® SQ 240CV Purification System



SQPAKGARM1
SQPAK™ Gard Pack

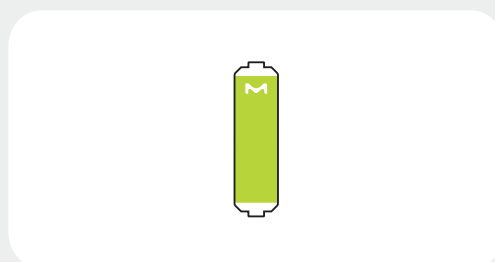

SQPAKPR0M1
SQPAK™ RO Cartridge

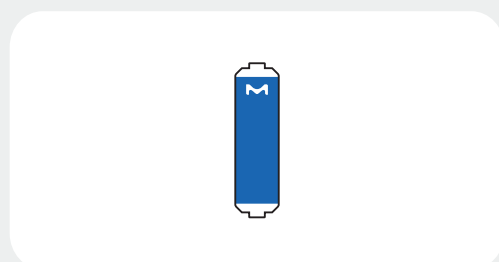

SQPAKQUAM1
SQPAK™ Quanta Cartridge

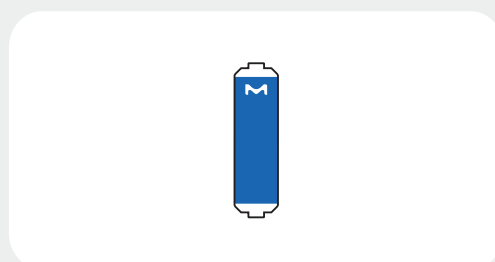

SQPAKT0CM1
SQPAK™ TOC Quanta Cartridge



SQPAKFINM1
SQPAK™ Final Filter



SQPAKBI0M1
SQPAK™ Bio Final Filter

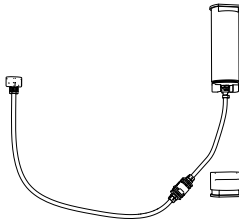

ZSQ240CTT0
Milli-Q® SQ Cleaning Tool



ZWCL01F50
ROProtect C

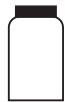

5874316024
EfferSan Effervescent Tablets (USA only) /
Pastilles effervescentes EfferSan (USA
uniquement) /
Compresse effervescenti EfferSan (USA) /
EfferSan-Brausetabletten (nur USA) /
Comprimidos efervescentes EfferSan
(EE.UU. solo) /
Tabletes efervescentes EfferSan (EUA
apenas) /
EfferSan 発泡錠(米国のみ) /
EfferSan 泡騰片(仅在美国) /
Пенящиеся таблетки EfferSan (только в
США)



5874316024C
EfferSan Effervescent Tablets (CA only) /
Pastilles effervescentes EfferSan (CAN
uniquement) /
Compresse effervescenti EfferSan (Canada) /
EfferSan-Brausetabletten (nur CA) /
Comprimidos efervescentes EfferSan (CAN
solo) /
Tabletes efervescentes EfferSan (Canadá
apenas) /
EfferSan 発泡錠(カナダのみ) /
EfferSan 泡騰片(仅在加拿大) /
Пенящиеся таблетки EfferSan (только в
Канаде)

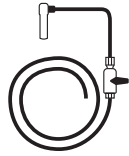

ZSQ240GVT0
Milli-Q® SQ Gravity Valve

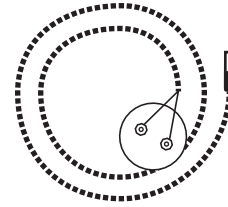

ZWATSENA1
Water sensor



ZFMQPR3BT0
Milli-Q® Pressure Regulator

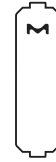

SQPAKACARE
SQPAK™ Care A Cleaner

Legal Notices

Mentions légales / Note legali / Rechtliche Hinweise / Avisos legales / Avisos Legais /
法的記載事項 / 法律声明 / Правовые уведомления

Legal information & warranty

It has always been Millipore SAS policy to continuously improve its products. The information in this document is subject to change without notice and should not be construed as a commitment by Millipore SAS. Millipore SAS assumes no responsibility for any errors that might appear in this document. This user manual is believed to be complete and accurate at the time of publication. In no event shall Millipore SAS be liable for incidental or consequential damages in connection with or arising from the use of this user manual.

Product warranty and limitation of liability

The applicable warranty and limitation of liability for the products listed in this publication may be found at www.SigmaAldrich.com within the "Conditions of Sale" applicable to your purchase transaction.

Copyright

© Millipore SAS 2023.

All rights reserved. This document or parts thereof may not be reproduced in any form without the written permission of Millipore SAS. The photographs illustrating the products are non-contractual.

Trademarks

New trademark names

The initial M, Millipore, Milli-Q, SQPAK (...), are trademarks of Merck KGaA, Darmstadt, Germany. Millipore SAS is an affiliate of Merck KGaA, Darmstadt, Germany. All other trademarks are trademarks of their respective manufacturers. The Life Science Business of Merck KGaA, Darmstadt, Germany operates as MilliporeSigma in the US and Canada.

ms-um-milli-q-sq-200p - V2.0

Mentions légales et garantie

La politique de Millipore SAS a toujours été d'améliorer constamment ses produits. Les informations figurant dans le présent document sont sujettes à modifications sans préavis et n'impliquent aucun engagement de la part de Millipore SAS. Millipore SAS décline toute responsabilité quant aux erreurs susceptibles de figurer dans ce document. Ce manuel d'utilisation est toutefois considéré comme exhaustif et exact au moment de sa publication. Millipore SAS ne saurait en aucun cas être tenue pour responsable des préjudices liés à ou découlant de l'utilisation de ce manuel.

Garantie des produits et limites de responsabilité

La garantie et les limites de responsabilité applicables aux produits figurant dans cette publication sont disponibles sur www.SigmaAldrich.com sous les "Conditions générales de vente" applicables à votre transaction commerciale.

Copyright

© Millipore SAS 2023.

Tous droits réservés. La reproduction, sous quelque forme que ce soit, de tout ou partie de ce manuel est interdite sans l'autorisation écrite de Millipore SAS. Les photographies illustrant les produits ne sont pas contractuelles.

Marques commerciales

Nouveaux noms de marques

Le M multicolore, Millipore, Milli-Q, SQPAK (...) sont des marques de Merck KGaA, Darmstadt, Allemagne. Millipore SAS est une filiale de Merck KGaA, Darmstadt, Allemagne. Toutes les autres marques citées sont des marques de leurs fabricants respectifs. L'activité Life Science de Merck KGaA, Darmstadt (Allemagne) opère sous le nom de MilliporeSigma aux États-Unis et au Canada.

Información legal y garantía

Siempre ha sido la política de Millipore SAS la mejora continua de sus productos. La información contenida en este documento está sujeta a cambios sin previo aviso y no debe interpretarse como un compromiso por parte de Millipore SAS. Millipore SAS no acepta responsabilidad alguna por cualquier error que pudiera aparecer en este documento. Se considera que este manual de usuario está completo y que la información contenida en él es exacta en el momento de su publicación. Bajo ningún concepto Millipore SAS será responsable de daños accidentales o indirectos en conexión con, o que surjan tras, el uso de este manual de usuario.

Garantía del producto y limitación de responsabilidad

La garantía aplicable y la limitación de responsabilidad a los productos indicados en esta publicación puede encontrarse en www.SigmaAldrich.com o en los «Términos y condiciones de venta» aplicables a su transacción de compra.

Copyright

© Millipore SAS 2023.

Todos los derechos reservados. Se prohíbe la reproducción total o parcial de este documento en cualquier forma sin la autorización por escrito de Millipore SAS. Las fotografías que ilustran los productos no son contractuales.

Marcas comerciales

Nuevos nombres de marcas comerciales

The initial M, Millipore, Milli-Q, SQPAK (...), son marcas comerciales de Merck KGaA, Darmstadt, Alemania. Millipore SAS es una filial de Merck KGaA, Darmstadt, Alemania. Todas las demás marcas comerciales son propiedad de sus respectivos fabricantes. La división Life Science de Merck KGaA, Darmstadt, Alemania, opera como MilliporeSigma en los Estados Unidos y en Canadá.

法律信息及保修条例

密理博公司 (Millipore SAS) 的一贯政策是不断改进其产品。本文件中的信息可能会有所变更，恕不另行通知。不得将这些信息解释为密理博公司 (Millipore SAS) 的承诺。对于文中可能出现的任何错误，密理博公司 (Millipore SAS) 概不负责。本用户手册在出版之时被认为是完整和准确的。在任何情况下，对于因使用本用户手册所引起的、或与此相关的任何附带或间接损失，密理博公司 (Millipore SAS) 概不负责。

产品保修及有限责任

适用于本出版物所列产品的保修条例和有限责任可以在下列网站上找到：www.SigmaAldrich.com (在适用于您的购买交易的“销售协议”中)。

版权

© 2023 年版权归密理博公司 (Millipore SAS) 所有。

保留一切权利。未经密理博公司 (Millipore SAS) 书面许可，不得以任何形式复制本文件或其任何部分。示例产品的照片不具有合约效力。

商标

新商标名称

首字母 M 标志、Millipore、Milli-Q、SQPAK (...) 是德国达姆施塔特市默克集团 (Merck KGaA) 的商标。密理博公司 (Millipore SAS) 是德国达姆施塔特市默克集团 (Merck KGaA) 的附属公司。所有其他商标均为其相应制造商的商标。德国达姆施塔特市默克集团 (Merck KGaA) 的生命科学业务在美国和加拿大以 MilliporeSigma 名称运营。

Informazioni legali e garanzia

È da sempre politica di Millipore SAS migliorare continuamente i propri prodotti. Le informazioni contenute in questo documento possono essere modificate senza preavviso e non devono, quindi, essere interpretate come una dichiarazione d'impegno da parte di Millipore SAS. Millipore SAS declina qualsiasi responsabilità per eventuali errori presenti. Questo manuale è considerato completo e accurato al momento della sua pubblicazione. Millipore SAS non potrà in alcun caso essere ritenuta responsabile di eventuali danni accidentali o indiretti, connessi o derivanti dall'utilizzo del presente manuale.

Garanzia e limitazione della responsabilità

È possibile consultare le condizioni di garanzia e le limitazioni della responsabilità relative ai prodotti descritti nella presente pubblicazione nel sito www.SigmaAldrich.com nell'ambito dei «Termini e Condizioni di vendita» applicabili alla transazione d'acquisto.

Diritti d'autore

© Millipore SAS 2023.

Tutti i diritti sono riservati. Il presente documento non può essere riprodotto né integralmente, né parzialmente, in nessuna forma senza il consenso scritto di Millipore SAS. Le fotografie illustrative dei prodotti sono extracontrattuali.

Marchi

Nomi di nuovi marchi

L'iniziale M, Millipore, Milli-Q, SQPAK (...), sono marchi di Merck KGaA, Darmstadt, Germania. Millipore SAS è una consociata di Merck KGaA, Darmstadt, Germania. Tutti gli altri marchi sono di proprietà dei legittimi detentori. Negli USA e in Canada, il settore life science di Merck KGaA, Darmstadt, Germania opera con il nome di MilliporeSigma.

Informações legais e garantia

A política da Millipore SAS sempre foi de melhorar continuamente seus produtos. As informações contidas neste documento estão sujeitas a alterações, sem aviso prévio, e não devem ser interpretadas como um compromisso por parte da Millipore SAS. A Millipore SAS não assume nenhuma responsabilidade por quaisquer erros que este documento possa conter. Este manual do usuário é considerado completo e exato no momento de sua publicação. Em nenhuma circunstância a Millipore SAS será considerada responsável por danos eventuais ou emergentes resultantes do uso deste manual do usuário ou a ele relacionados.

Garantia do produto e limitação de responsabilidade

A garantia aplicável e a limitação de responsabilidade relativas aos produtos listados nesta publicação podem ser encontradas no site www.SigmaAldrich.com, nas «Conditions of Sale» (Condições de venda) aplicáveis à sua transação comercial.

Direitos autorais

© Millipore SAS 2023.

Todos os direitos reservados. Este documento ou partes dele não podem ser reproduzidos de qualquer maneira, salvo com consentimento por escrito da Millipore SAS. As imagens que ilustram os produtos não são contratuais.

Marcas comerciais

Novos nomes de marcas comerciais

The initial M, Millipore, Milli-Q, SQPAK (...), são marcas comerciais da Merck KGaA, Darmstadt, Alemanha. Merck SAS é uma afiliada da Merck KGaA, Darmstadt, Alemanha. Todas as outras marcas comerciais são marcas comerciais dos seus respectivos fabricantes. A divisão de Life Science da Merck KGaA, Darmstadt, Alemanha, opera como MilliporeSigma nos EUA e Canadá.

Юридическая информация и гарантия

Основной чертой политики Millipore SAS всегда было непрерывное совершенствование продукции компании. Информация, содержащаяся в данном документе, может быть изменена без уведомления и не должна толковаться как обязательство со стороны компании Millipore SAS. Компания Millipore SAS не несет ответственности за ошибки, которые могут содержаться в настоящем документе. Данное руководство пользователя считается полным и точным на момент публикации. Компания Millipore SAS не при каких обстоятельствах не несет ответственности за прямые или косвенные убытки, связанные с данным руководством пользователя или его использованием.

Гарантия качества изделия и ограничение ответственности

Применимые гарантии и ограничение ответственности в отношении продуктов, перечисленных в данном документе, можно найти на веб-сайте www.SigmaAldrich.com в разделе «Условия продажи», относящемся к типу вашей сделки приобретения.

Авторские права

© Millipore SAS, 2023.

Все права защищены. Запрещена любая форма воспроизведения данного документа или его частей без письменного разрешения Millipore SAS. Фотографии, иллюстрирующие продукцию, не являются контрактными.

Товарные знаки

Новые товарные знаки

Начальная буква M, Millipore, Milli-Q, SQPAK (...) являются товарными знаками компании Merck KGaA, Darmstadt, Германия. Millipore SAS является дочерней компанией Merck KGaA, Darmstadt, Германия. Все остальные торговые знаки являются товарными знаками соответствующих производителей. В США и Канаде медико-биологическое отделение компании Merck KGaA, Darmstadt, Германия работает под наименованием MilliporeSigma.

Rechtliche Hinweise & Garantie

Kontinuierliche Produktverbesserung ist seit jeher einer der Grundsätze der Millipore SAS. Die Informationen in diesem Dokument können jederzeit ohne Vorankündigung geändert werden und stellen keine Verpflichtung seitens der Millipore SAS dar. Millipore SAS übernimmt keine Verantwortung für etwaige Fehler in diesem Dokument. Zum Zeitpunkt der Veröffentlichung gilt dieses Benutzerhandbuch als vollständig und korrekt. Millipore SAS übernimmt keine Haftung für Neben- oder Folgeschäden, die sich aus der Verwendung dieses Benutzerhandbuchs ergeben.

Produktgarantie und Haftungsbeschränkung

Die allgemeine Gewährleistung und Haftungsbeschränkung für die Produkte in diesem Dokument finden Sie online unter www.SigmaAldrich.com (in den jeweiligen „Allgemeinen Verkaufsbedingungen“).

Copyright

© Millipore SAS 2023.

Alle Rechte vorbehalten. Dieses Handbuch oder Teile davon dürfen ohne schriftliche Genehmigung der Millipore SAS in keiner Form reproduziert werden. Die Fotos, die Produkte abbilden, sind nicht vertraglich bindend.

Markennamen

Neue Markennamen

Das Initial M, Millipore, Milli-Q, SQPAK (...) sind Marken der Merck KGaA, Darmstadt, Deutschland. Millipore SAS ist ein Tochterunternehmen der Merck KGaA, Darmstadt, Deutschland. Alle anderen Marken sind Eigentum der jeweiligen Inhaber. Der Unternehmensbereich Life Science der Merck KGaA, Darmstadt, Deutschland tritt in den USA und Kanada als MilliporeSigma auf.

法的信息と保証

Millipore SASでは常に製品を改善し続けることを方針としています。本文書の情報は、予告なしに変更されることがあり、Millipore SASによる言質として解釈されるべきものではありません。Millipore SASは、本書内で発見される可能性のあるいかなる誤りについても責任を負いません。この取扱説明書は発行時点において網羅的で正確であると確信しています。Millipore SASはいかなる場合においても、この取扱説明書の使用に関連または起因する偶発的または間接的損害の責任を負いません。

製品保証と法的責任限度

この取扱説明書に記載の製品に関する保証と法的責任限度は、www.SigmaAldrich.comの、「ご購入に関する「販売条件」」に記載しています。

Copyright

© Millipore SAS 2023.

All rights reserved. この文書はその全体または一部分でも、Millipore SASの書面による許可無くしてはいかなる形式でも複製を禁じます。製品を图示する写真は契約の一部を成しません。

商標

新商標名称

Mのイニシャル、Millipore、Milli-Q、SQPAK (...) はドイツ、ダルムシュタット所在のMerck KGaAの商標です。Millipore SASは、ドイツ、ダルムシュタット所在のMerck KGaAの関連会社です。その他すべての商標は、該当する企業、団体の商標です。ドイツ、ダルムシュタット所在のMerck KGaAのライフサイエンス事業は、米国、カナダではMilliporeSigmaとして運営しています。

