

# Mobius® Single-Use Technology Supporting ADC Processing



Adam Sokolnicki, Manufacturing Sciences and Technology, MilliporeSigma

## Introduction

MilliporeSigma offers a complete single-use portfolio for bioprocessing through its Mobius® product line. From 2D storage bags, mixers and bins to fully-automated Mobius® SMART FlexReady chromatography and tangential flow filtration systems to highly customized final filling assemblies, all pieces of the biomufacturing process are available in a single-use format. This poster focuses on three of these specific technologies well suited for use in antibody drug conjugate production: mixers, chromatography, and TFF. Two families of SUM are available: Mobius® Mix, which provides low shear, gentle mixing suitable even for cell suspension, and Power Mix, a high performance mixer for rapid dissolution and dispersion of solutions. The Mobius® FlexReady Solutions with SMART Flexware® Assemblies for Chromatography and TFF are predesigned and optimized systems using innovative SMART flow paths to ease the implementation of single-use unit operations in your facility.

Here we will show examples of performance data which helps explain the features and benefits of these single-use technologies. Flexible configurations, blend times and scalability assessments for the Mixers. Pressure profiles, gradient accuracy, and column qualification for the chromatography system. Minimum working volume, recovery yields, and flow rate accuracy for the TFF system. Common elements of the two SMART systems are presented.

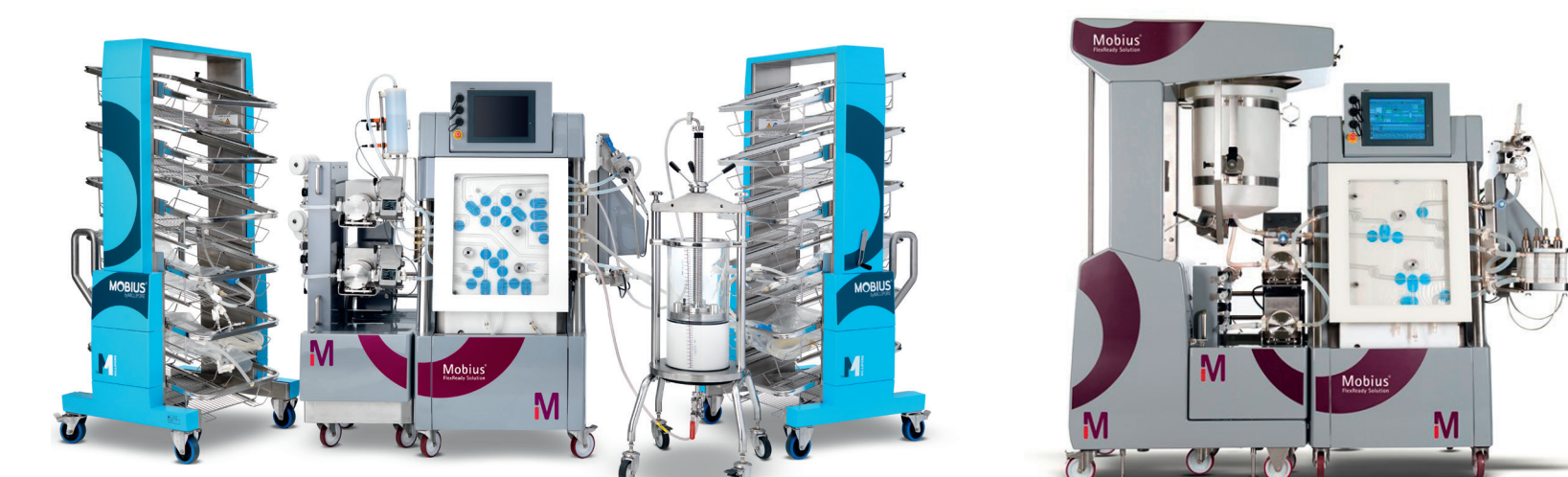

Mobius® FlexReady Solution for Chromatography with Smart Flexware assemblies

## Mobius® Mix & Power Mix

These two SUM share some features which facilitate product adoption:

- Ability to customize Mixer hardware and single-use bags Jacketed stainless steel vessel (Figure 1) with RTD for temperature control and integrated load cells for weight measurement. Analytical probes such as pH or conductivity can be integrated. Remote I/O modules enable control through local panel or plant connection. The top inlet and bottom outlet lines on the Mix bag design (Figure 2) accommodate any connector including Lynx® S2S or CDR as well as phobic vent or phobic product filters. Top ports, sampling and probe ports are selectable.

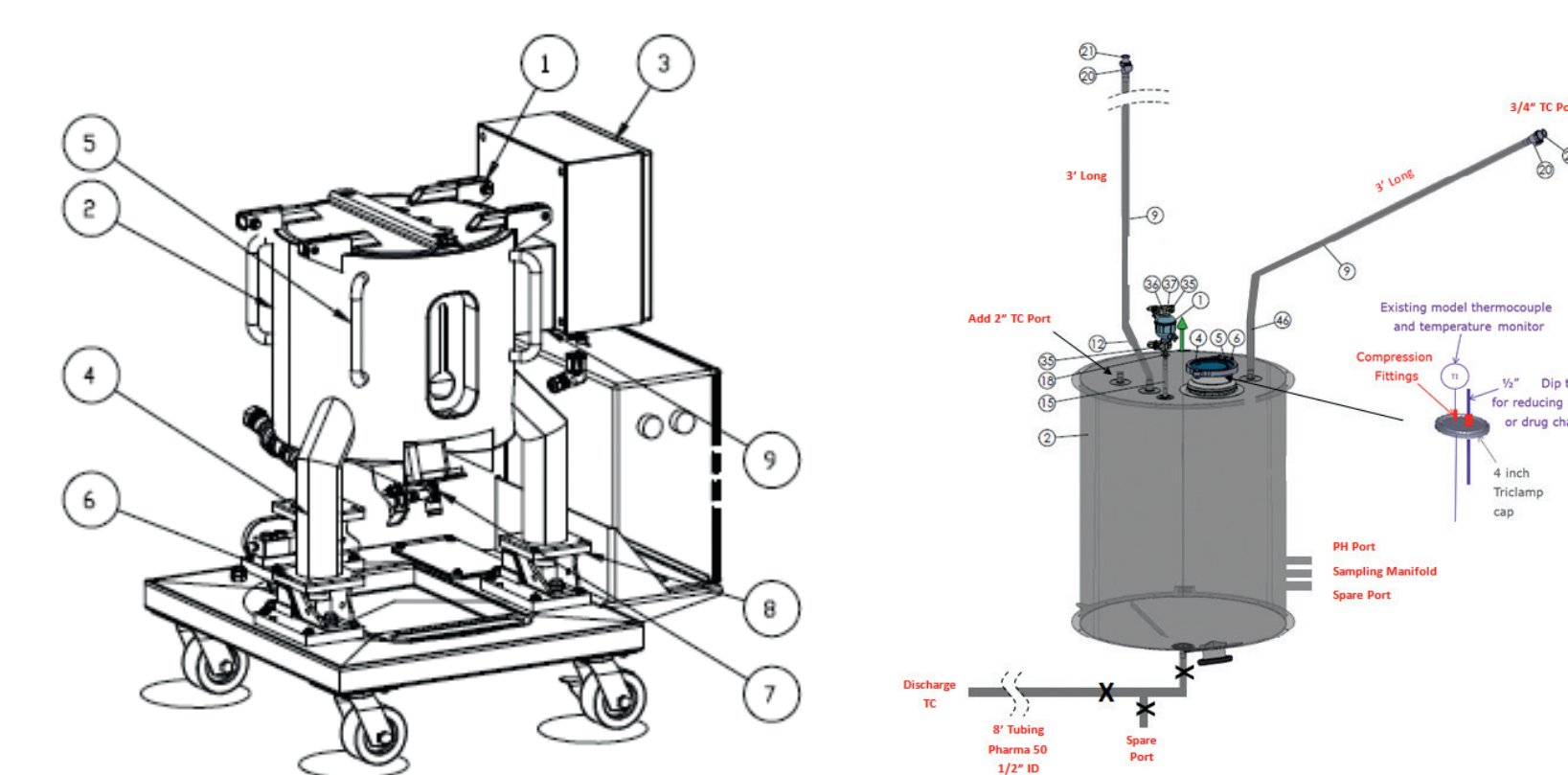

Figure 1: Custom hardware

Figure 2: Custom Mix bag

- Geometrically similar mixer families, to facilitate scale up The vessel and impeller dimensions are scaled according to their nominal volume. Three different impeller sizes generate appropriate power and flow in each vessel.

Mixer	Min Sampling Volume (L)	Max Volume (L)	Vessel Diameter T (cm)	Aspect Ratio H/T	Impeller Diameter D (cm)	Impeller Ratio D/T	Impeller Power Np	Impeller Pumping # Nq	Max RPM
10	3	15	27.8	0.68	6.50	0.23	2.5	0.87	1000
50	15	55	38.8	1.18	6.50	0.17	2.5	0.87	1000
100	30	110	52.3	0.98	10.0	0.19	2.9	0.91	500
200	60	220	65.4	1.00	10.0	0.15	2.9	0.91	500
500	150	550	90.4	0.95	17.5	0.19	3.0	0.92	250
1000	300	1100	111.0	1.03	17.5	0.16	3.0	0.92	250

Table 1: Mobius® Mix dimensional scalability

- Well-characterized mixing performance

Liquid-liquid blend times (Figure 3) have been characterized for a range of process viscosities in each mixer. Turbulence maps (Figure 4) indicate mixing vigor. Empirical correlations (Figures 5, 6) provide reliable scale-up methodology.

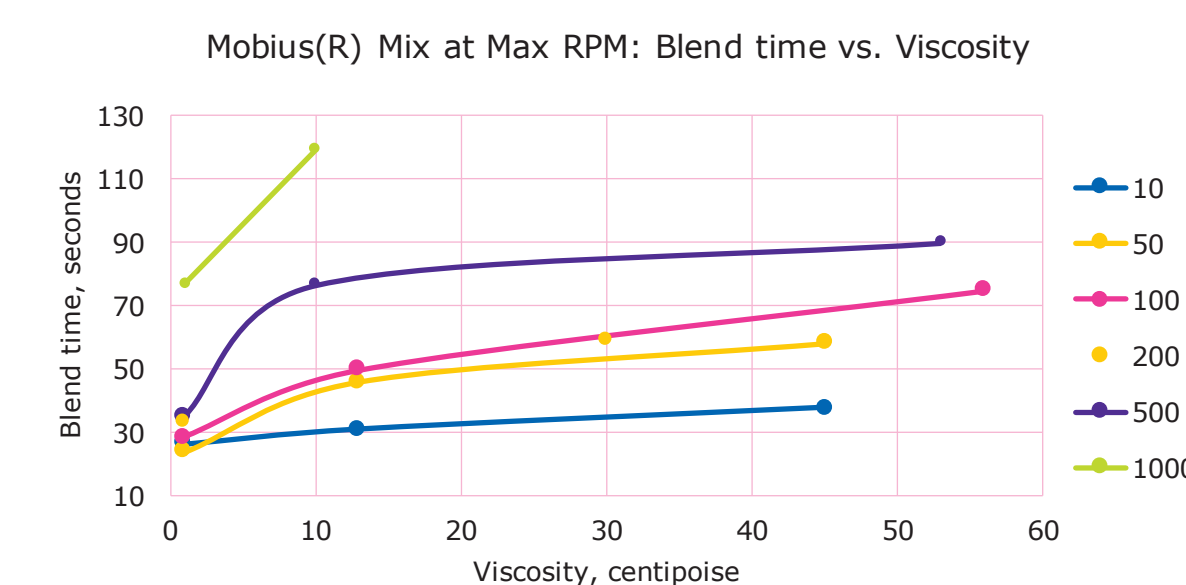

Figure 3: Liquid blending in Mobius® Mix

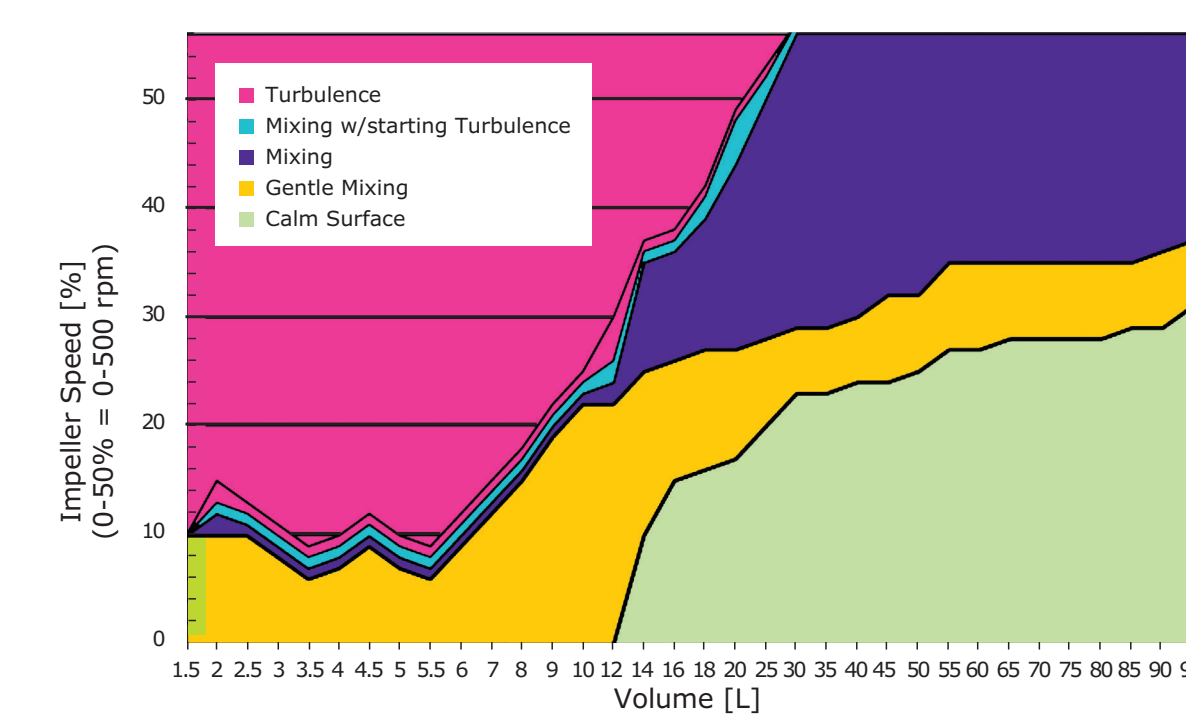

Figure 4: Turbulence map for Mobius® Mix100 system

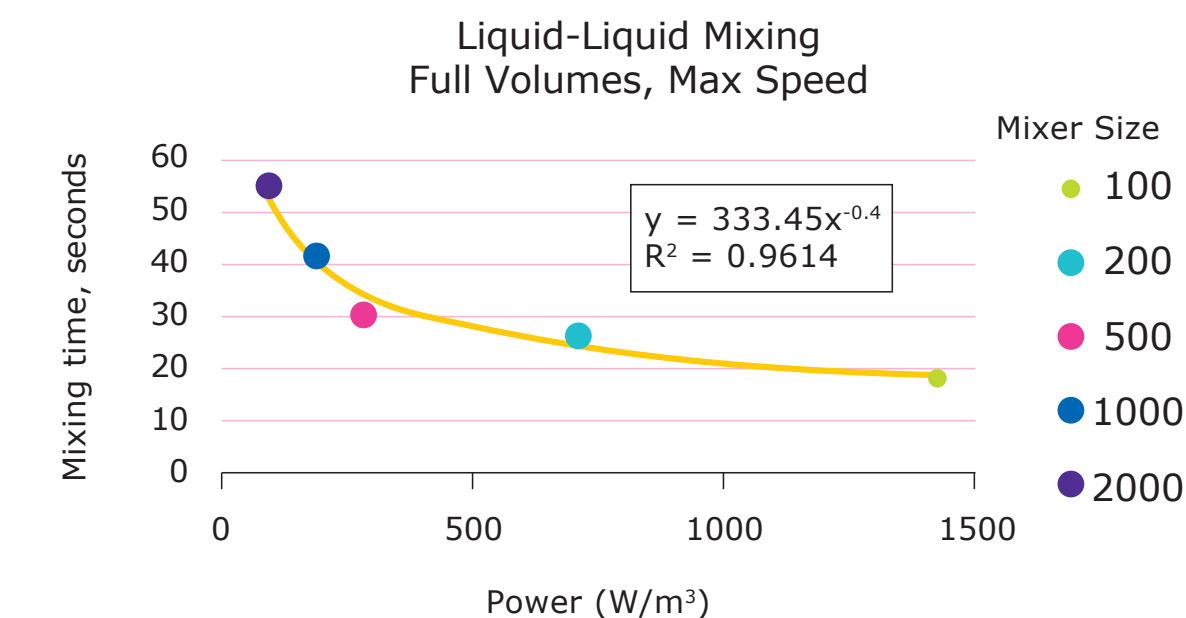

Figure 5: Scaling correlation for liquid in Mobius® Power Mix

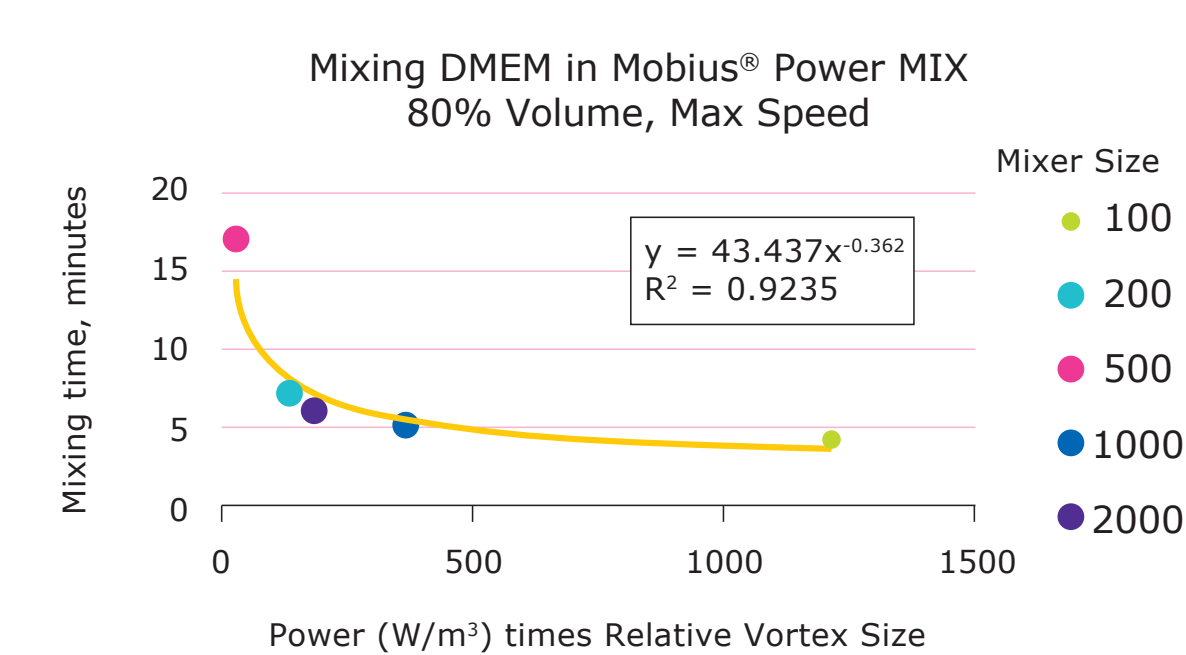

Figure 6: Scaling correlation for solids in Mobius® Power Mix

## Mobius® FlexReady Chromatography

Two system sizes allow flow rates between 0.1 and 8.0 L/min at pressures up to 4 barg (58 psig). Three sizes of flow path kit further optimize process fit. As an indication of performance, pressure profiles are shown for three flow path arrangements, each specifying the position of the bubble trap, pre-column filter, and a column operating in forward mode (Figure 7).

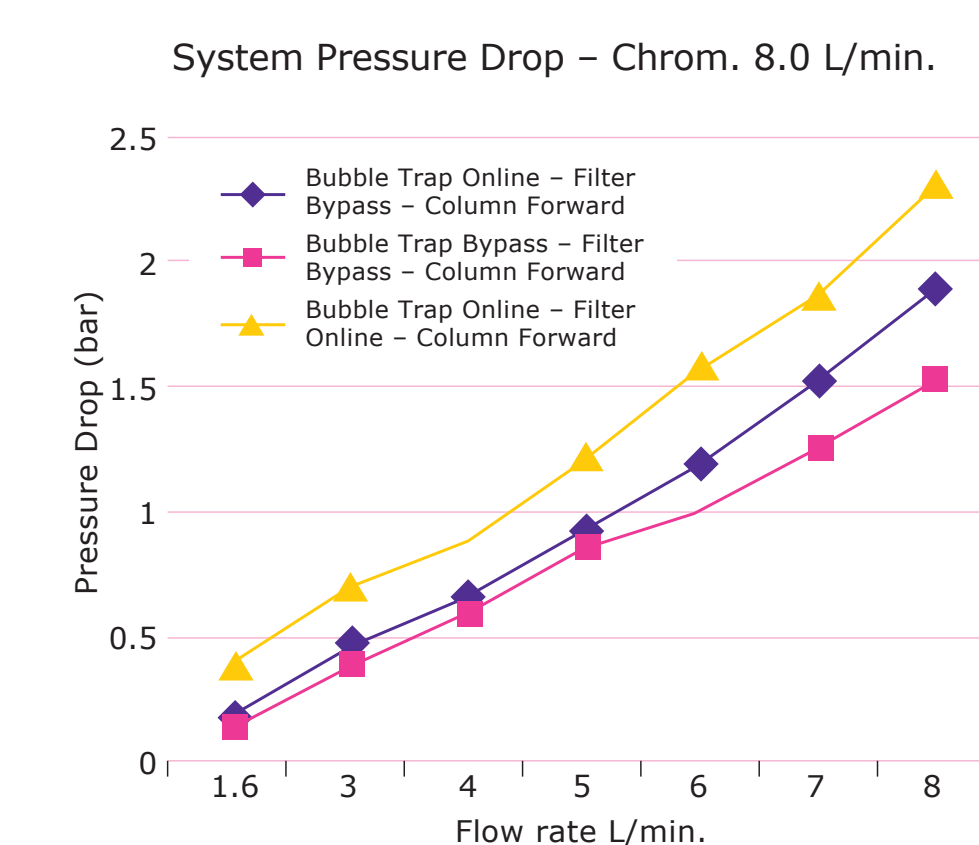

Figure 7: SU chromatography system pressure performance at up to 8 L/min

The two-pump system provides linear gradients, controlled by either flow (Figure 8) or conductivity (Figure 9), with a high degree of accuracy: < 2% error over 10-90% gradient.

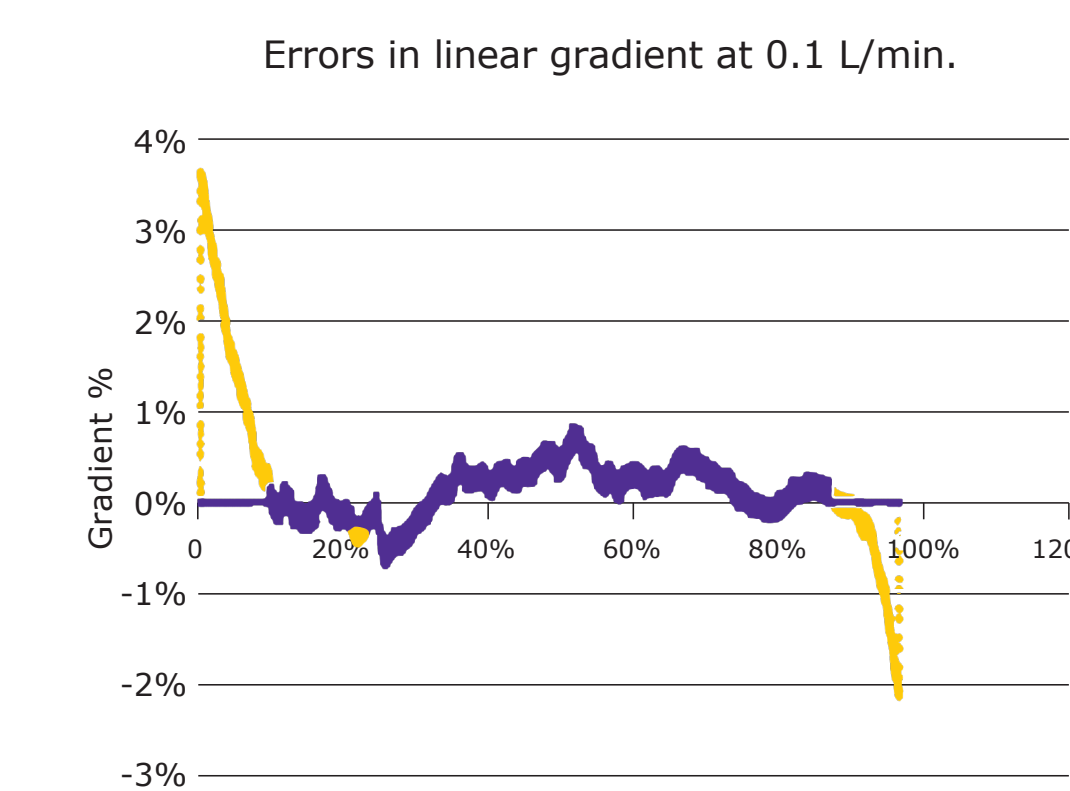

Figure 8: 10-90% gradient performance of the dual pump system

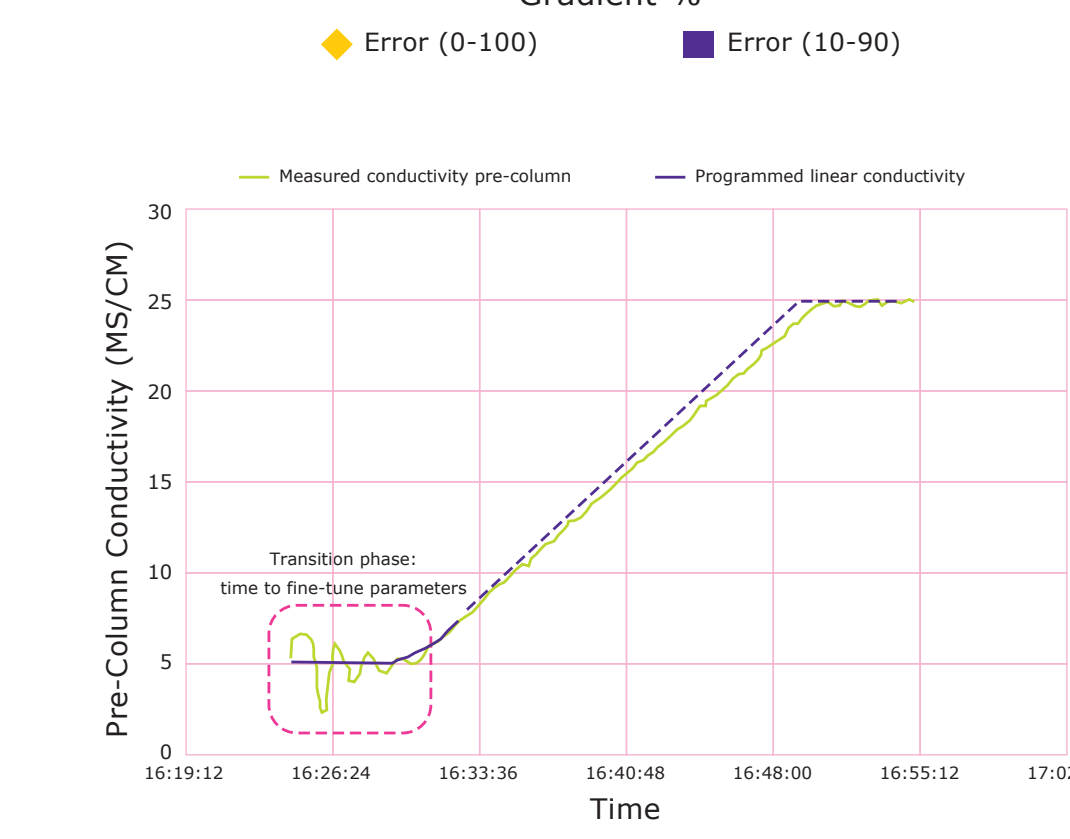

Figure 9: Conductivity gradient performance

Column qualification is enhanced by features of the Flexware® kit that minimize axial dispersion of the injected solution. Tight asymmetries and low HETP values are easily achievable (Figure 10).

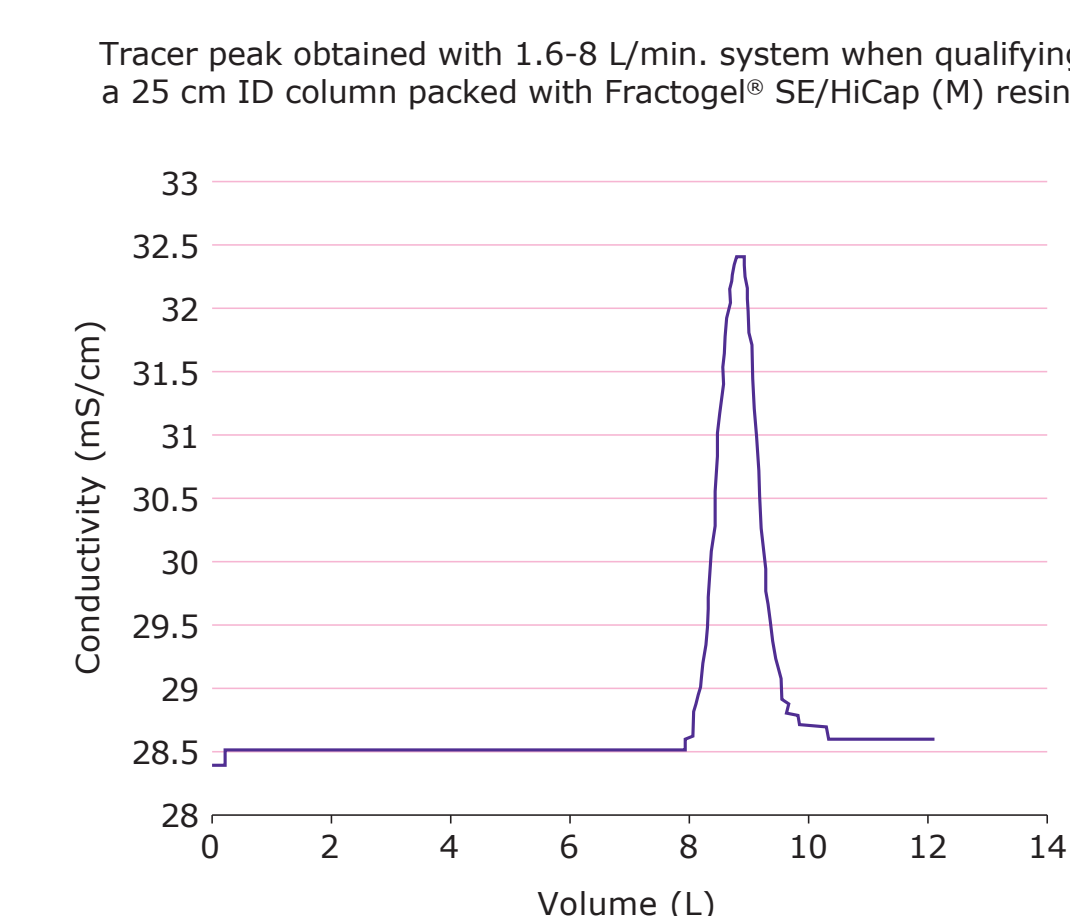

Figure 10: Column qualification: HETP: 0.027 cm, Asym: 1.1, Acceptance Criteria: HETP: < 0.050 cm, Asym: 0.7 - 1.4

## Mobius® FlexReady TFF

Two system sizes accommodate membrane areas up to 10 m². Three vessel options (50-200 L) featuring a levitating magnetically coupled impeller provide efficient mixing down to 7% nominal volumes. The feed and retentate ports located on the vessel bottom, along with optimized flow path hold up volume enable ultra-low Minimum Working Volumes across the range of feed pump flow rates (Figure 11). Further enhancing MWV, the retentate diverter plate prevents spouting and short-circuiting by directing flow tangentially to the vessel walls (Figure 12).

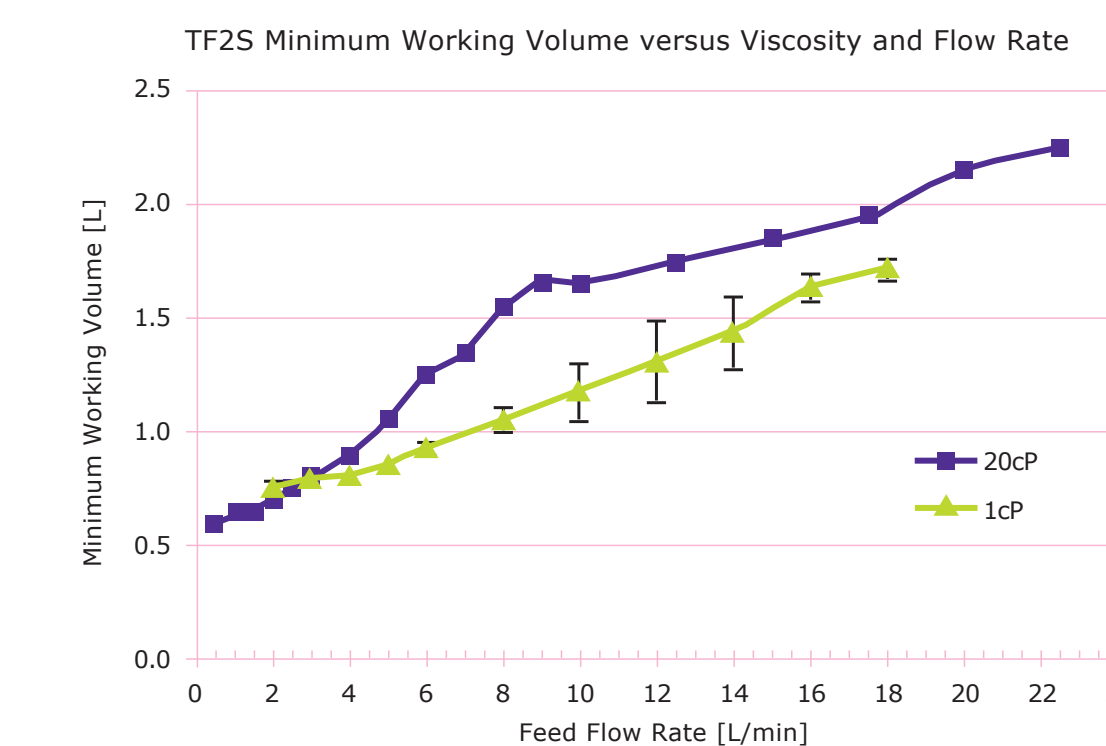

Figure 11: Minimum working volume in the TFF system is extremely efficient, allowing less than 1 L



Figure 12: Retentate diverter plate directs return flow tangentially, preventing short-circuiting to the center feed port. Allowing less than 1 L

Sloped piping with zero dead-leg valves and a 4-step recovery process via buffer or air provides excellent product recovery, optimizing the yield vs. dilution curve (Figure 13).

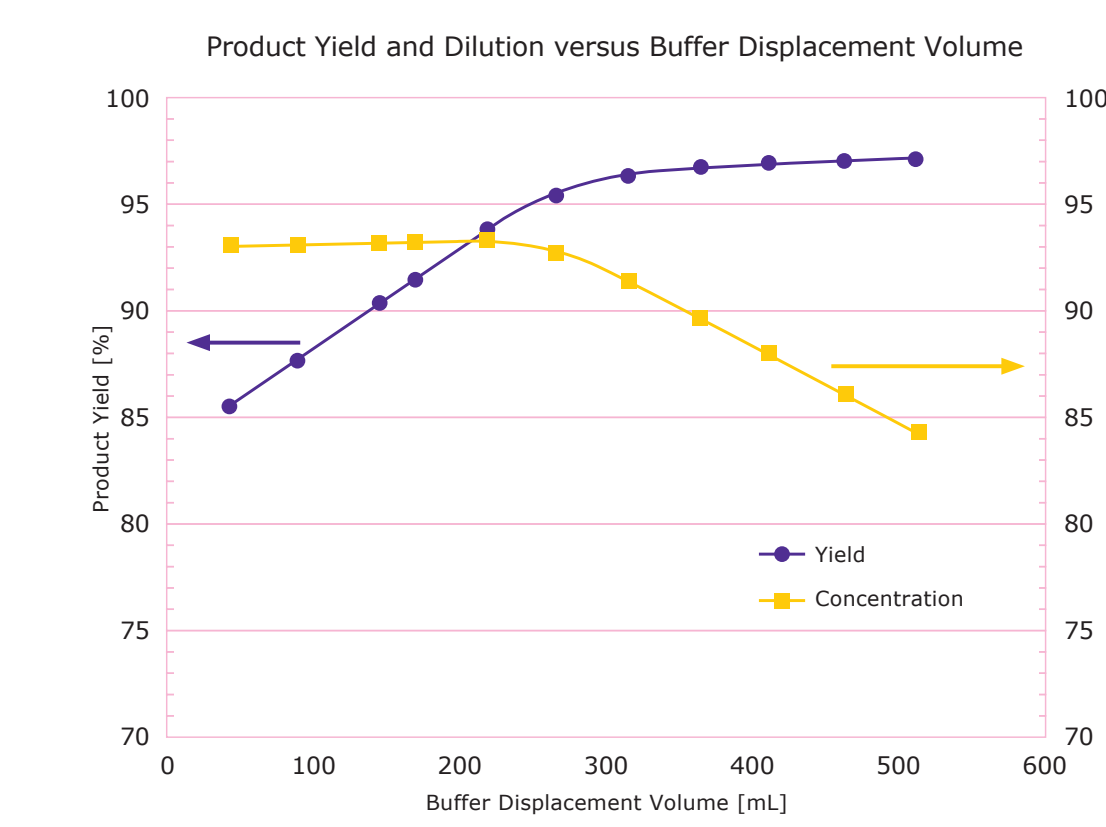

Figure 13: Recovery yield improves as dilution grows

Feed pump flow control, one of 2 PID loops, is managed by an algorithm, removing the feed flow meter and reducing holdup volume. Accuracy is <= 10% error (Figure 14).

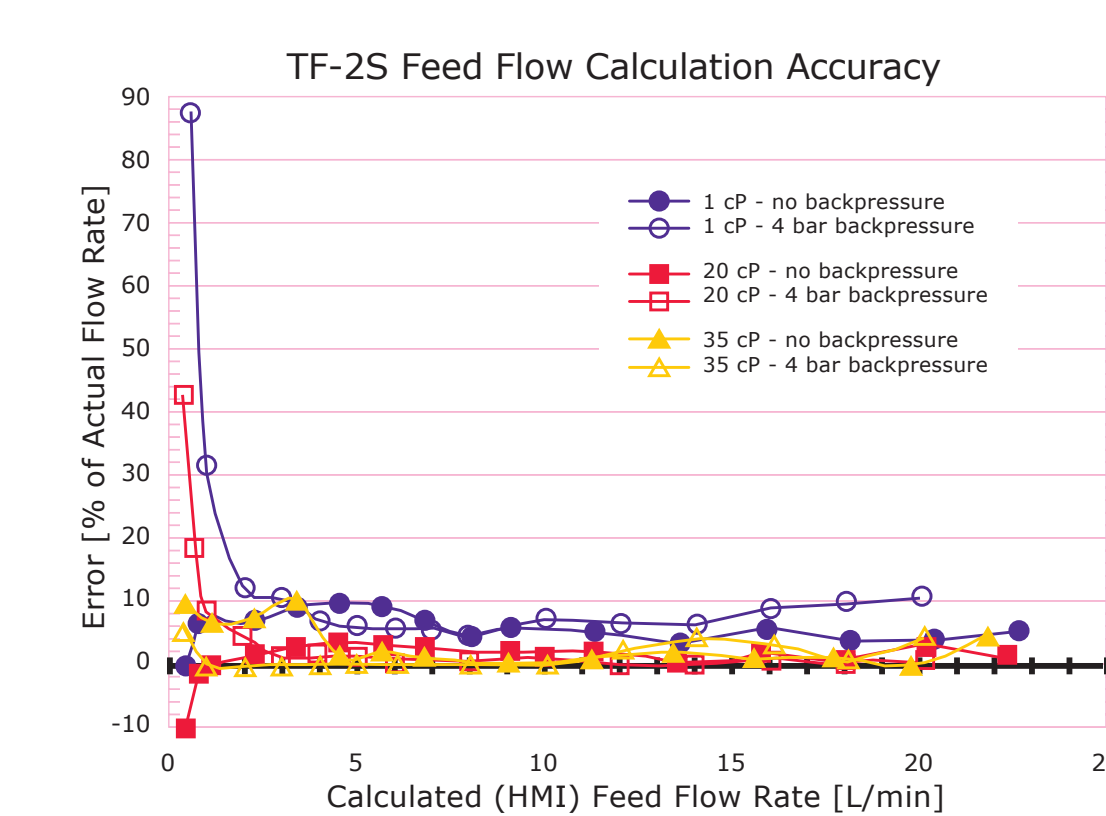

Figure 14: Feed pump is controlled by an algorithm using speed and pressure

Method development in the Recipe Editor tool (Figure 15) is aided by the available template operations, to guarantee robust and reproducible purification steps. Sharing a common user interface enhances modularity approach.

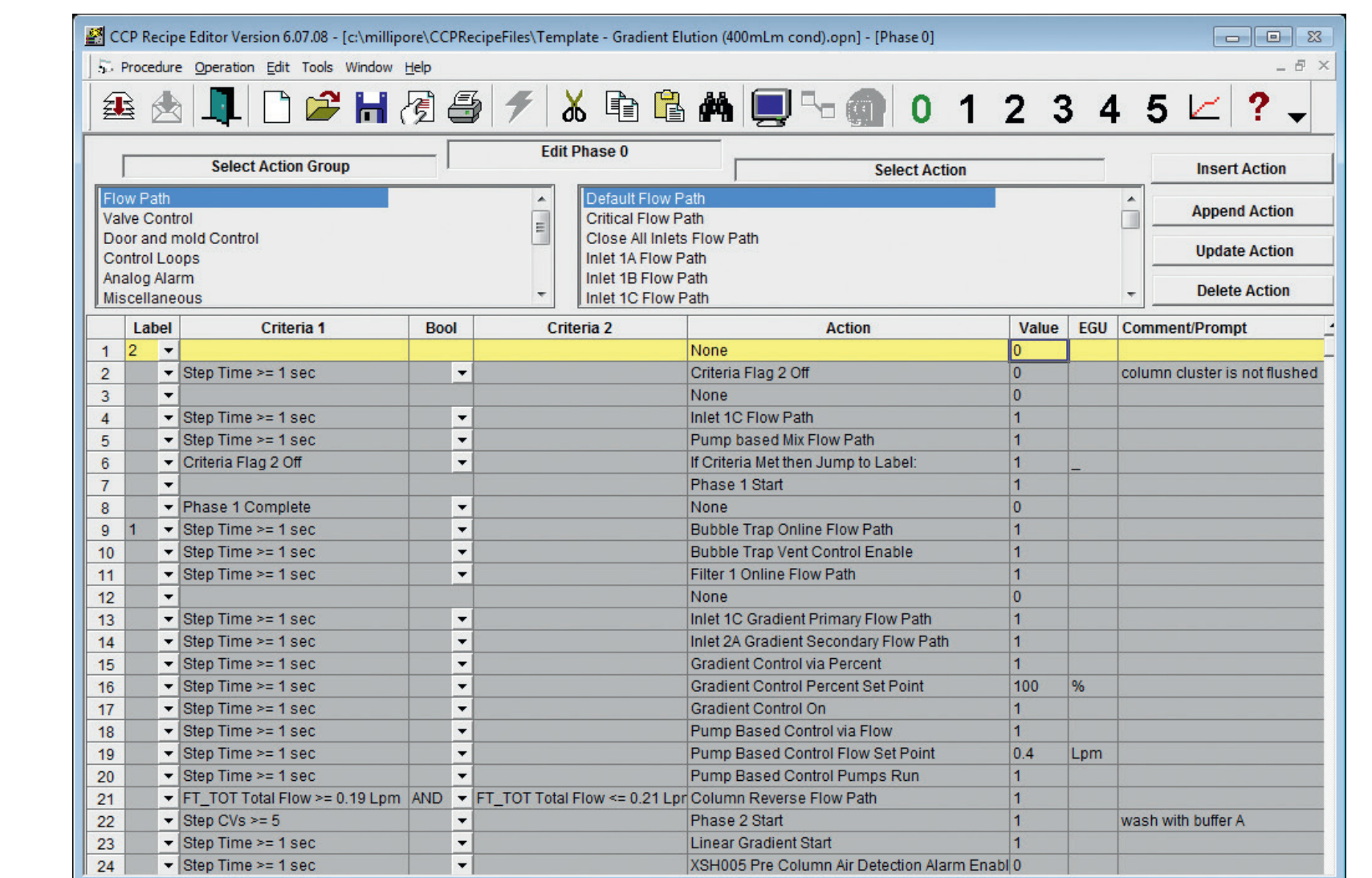

Figure 15: Recipe Templates simplify process automation

## SMART Commonality

Unique and proprietary clamshell body converts from Chromatography to TFF using the same skirts (Figure 16). A single sensor body for UV, pH, and conductivity is available as a single-use cell or multi-use sensor (Figure 17).



Figure 16: Clamshell allows quick change over between system types

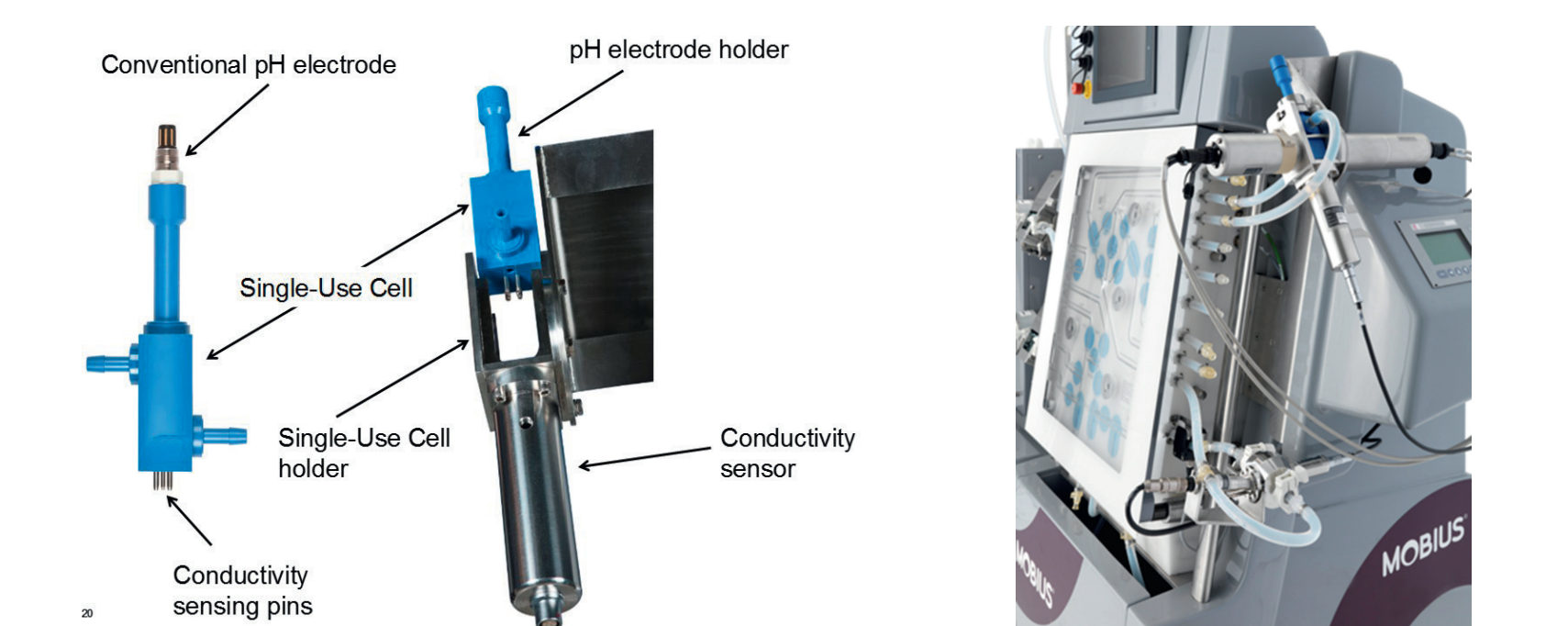

Figure 17: SU sensor body and instrument cluster is common

## EMDMillipore.com

We provide information and advice to our customers on application technologies and regulatory matters to the best of our knowledge and ability, but without obligation or liability. Existing laws and regulations are to be observed in all cases by our customers. This also applies in respect to any rights of third parties. Our information and advice do not relieve our customers of their own responsibility for checking the suitability of our products for the envisaged purpose.

The life science business of Merck KGaA, Darmstadt, Germany operates as MilliporeSigma in the U.S. and Canada.

© 2019 Merck KGaA, Darmstadt, Germany and/or its affiliates. All Rights Reserved. MilliporeSigma, the vibrant M, Mobius, Flexware and Lynx are trademarks of Merck KGaA, Darmstadt, Germany or its affiliates. All other trademarks are the property of their respective owners. Detailed information on trademarks is available via publicly accessible resources. Lit. No. MS\_PS3864EN